

85 cents

*hr*_{nr}

focus
on
communications
technology . . .

ham **radio**

magazine

AUGUST 1974

high-power solid-state **LINEAR POWER AMPLIFIER**

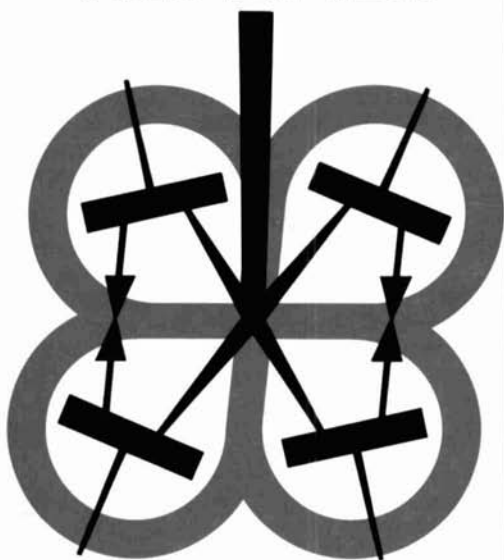

this month

- wind loading on antenna structures 16
- vhf fm scanners 28
- ssb transceiver 34
- variable-speed RTTY 50

Powerful Portability

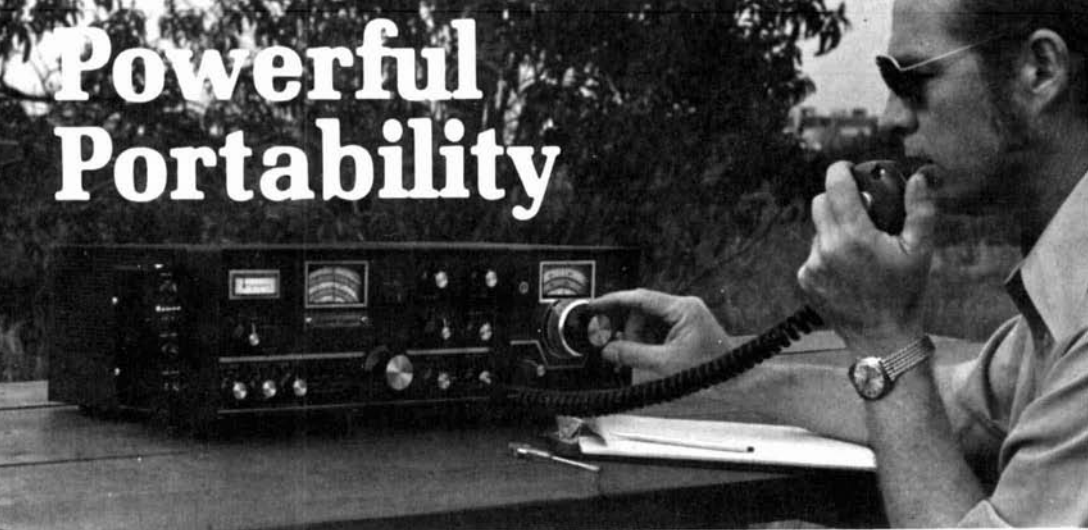

Team-Up with Dual Cygnets to Punch Through QRM — AND Do It Economically!

Analyze the real expense of your ham station. Add up all your costs and divide by your rated wattage. Find out what you're really paying for every watt you use.

Want quality and functional economy? Here's a suggestion: Install a Swan 1200X Cygnet Linear Amplifier driven by a Swan 300B Cygnet *de novo* Transceiver. Both have internal power supplies, operate 10 through 80 meters, have SSB and CW modes, and utilize 8950 tubes for RF amplification. A built-in speaker and CW sidetone monitor comes with the 300B while the 1200X has excellent metering plus a bypass switch so you can operate barefoot. Swan provides the quality and functions, now look at the economics.

Add the \$519.95 price of the 300B to the \$299.95 price of the 1200X. Then divide by 1200 watts P.E.P. input. The result is a most respectable power level for a very low cost of just 68¢ per watt!

Try to beat that figure anywhere else, today.

It's pure common sense — the heart of any station is its quality; its power; and, these days, its economy. Investigate the Cygnets — you won't be disappointed. If you still want a few extras, like a VOX or VFO, Swan has them, too. Visit an authorized Swan dealer soon or, if you wish, you can use the coupon below to order your Cygnets now.

Gentlemen:

Please ship the following Swan products best way.

- 300B Cygnet *de novo* Transceiver (300 watts P.E.P. input) \$519.95
- 300B with SS-16B Super-selective I.F. filter \$589.95
- 1200X Cygnet Linear Amplifier (1200 watts P.E.P. input) \$299.95
- 508 External VFO \$189.95
- 14-A DC Converter \$49.95
- VX-2 Plug-in VOX \$44.95

TOTAL AMOUNT OF ORDER IS \$ _____

- 20% down payment enclosed, ship C.O.D.
- Full payment enclosed
- 10% down payment enclosed, charge to my Swan Credit# _____

Name: _____

Address: _____

City: _____ State: _____

Amateur Call: _____ Zip: _____

68¢ PER WATT!



1200 watt P.E.P. input,
1200X Cygnet Linear Amplifier

Use this coupon to order
direct from the factory.
(California residents please include sales tax.)

DEALERS THROUGHOUT THE WORLD
or order direct from



SWAN
ELECTRONICS

A subsidiary of Cubic Corporation

305 Airport Road
Oceanside, CA 92054
Telephone (714) 757-7525

If You Haven't Seen An **ALPHA 374**



Then You Don't Know What A **MODERN COOL KILOWATT** looks like!

ALPHA 374 is rated at a solid kilowatt of continuous DC Input on SSB, CW, RTTY, SSTV . . . even AM! So are one or two other big linears you might be tempted to compare with the '374. But *none* of the others has *even one* of these State-Of-The-Art **ALPHA 374** conveniences and quality features:

- INSTANT BANDCHANGE WITHOUT TUNE-UP - Just turn the bandswitch and transmit.
- SELF-CONTAINED DESK TOP CABINET - One beautiful cubic foot, only 55 pounds.
- EIMAC CERAMIC TUBES with total dissipation rating of 1200 watts.
- DIRECT METERING OF PEAK (PEP) DC INPUT AND RF OUTPUT.
- AMPLIFIED ALC GENERATOR, green and red LED drive level indicators.

Every **ALPHA 374** is backed by ETO's full year warranty and traditional service. Contact your dealer today - or if more convenient call ETO direct - for full details and immediate delivery of your **ALPHA 374**. \$1195.



EHRHORN TECHNOLOGICAL OPERATIONS, INC.
BROOKSVILLE, FLORIDA 33512
(904) 596-3711

The inside story

Few things have ever been more true than the old saying "you can't judge a book by its cover". So—we've taken the covers off to give you the inside story.

Quality workmanship and components, combined with ease of maintenance and proven reliability are changing our story... to legend.

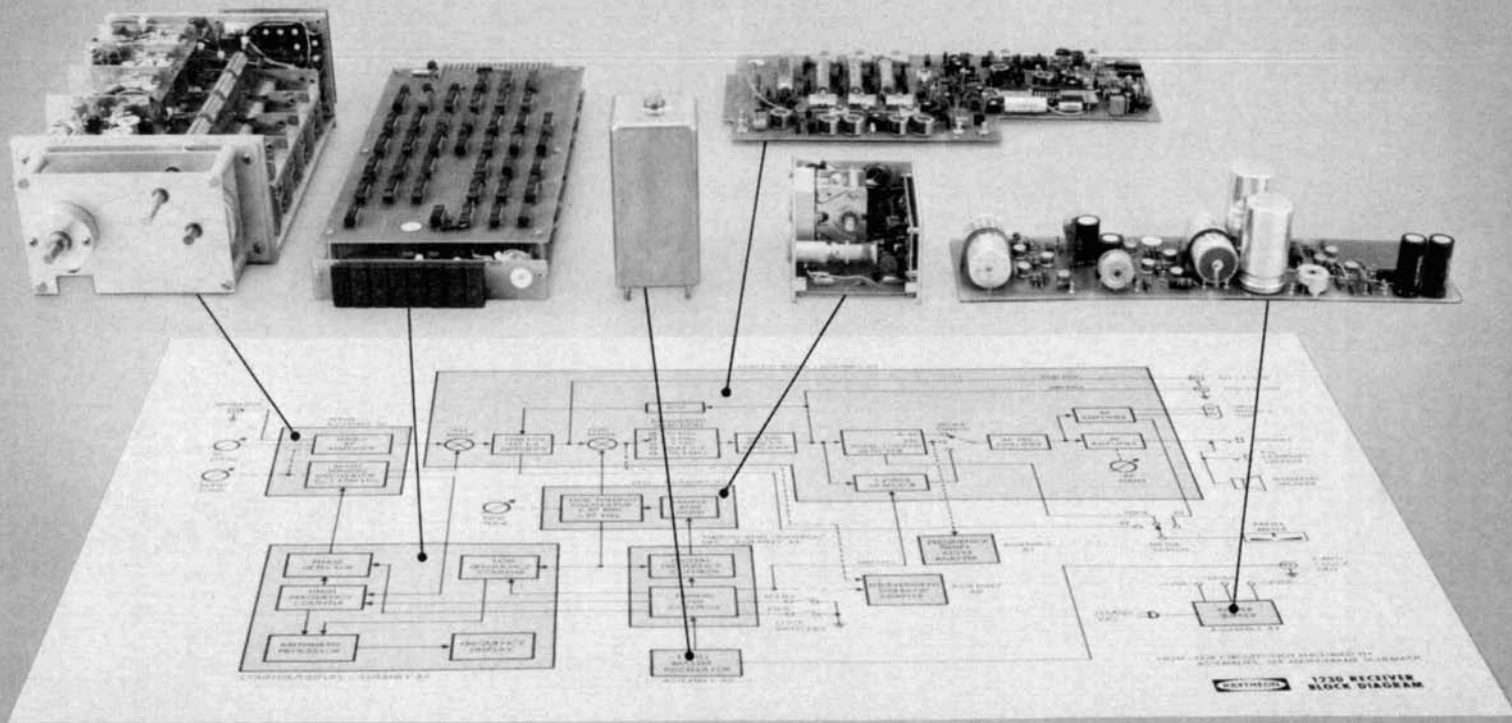

Model 1230A HF Receiver—\$3930.
For more information please write to us.

Raytheon Co.
Dept. 9210
P. O. Box 1542
Goleta, California 93017
(805) 967-5511

August, 1974
volume 7, number 8

staff

James R. Fisk, W1DTY
editor-in-chief

Joseph Schroeder, W9JUV
editor

Patricia A. Hawes, WN1QJN
assistant editor

J.Jay O'Brien, W6GDO
fm editor

Alfred Wilson, W6NIF
James A. Harvey, WA6IAK
associate editors

Wayne T. Pierce, K3SUK
cover

T.H. Tenney, Jr. W1NLB
publisher

Hilda M. Wetherbee
assistant publisher
advertising manager

offices

Greenville, New Hampshire 03048
Telephone: 603-878-1441

ham radio magazine is
published monthly by
Communications Technology, Inc
Greenville, New Hampshire 03048

Subscription rates, world wide
one year, \$7.00, three years, \$14.00
Second class postage
paid at Greenville, N.H. 03048
and at additional mailing offices

Foreign subscription agents
United Kingdom
Radio Society of Great Britain
35 Doughty Street
London WC1N 2AE, England

All European countries
Eskil Persson, SM5CJP, Frotunagränd 1
19400 Upplands Vasby, Sweden

African continent
Holland Radio, 143 Greenway
Greenside, Johannesburg
Republic of South Africa

Copyright 1974 by
Communications Technology, Inc
Title registered at U.S. Patent Office
Printed by Wellesley Press, Inc
Framingham, Massachusetts 01701, USA

Microfilm copies of current
and back issues are available
from University Microfilms
Ann Arbor, Michigan 48103



contents

6 high-power linear power amplifier

W. Steven Chambers

16 wind loading on antenna structures

John J. Nagle, K4KJ

28 vhf fm scanners

Joseph J. Carr, K4IPV

34 IC ssb transceiver

Brian D. Comer, G3ZCV

40 harmonic phase detector

Henry S. Keen, W5TRS

44 shipboard amateur radio installations

Robert P. Haviland, W3MR

50 variable-speed RTTY control

Keith H. Sueker, W3VF

56 battery power

Edward M. Noll, W3FQJ

4 a second look

94 advertisers index

56 circuits and techniques

83 flea market

62 ham notebook

64 new products

94 reader service

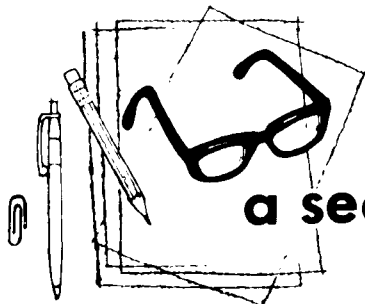

a second look

by jim
fisk

In case you haven't noticed, solid-state technology has finally caught up to the vacuum tube. A good example of modern semiconductors at work is illustrated in the high-power linear amplifier featured in this issue. Modern transistors also provide good gain and low noise well into the microwave region, and microwave power devices are now available. If you think the prices are still too high, forget for a moment those 2C39s, 2K25s and other exotic hardware you bought for peanuts on the surplus market. Compared with the decade-old *list* price of vacuum tubes that would do the same job, modern high-performance semiconductors are a best buy.

While millions of research hours (and dollars) have been spent in the pursuit of higher gain, lower noise and higher power rf and microwave devices, even more has been spent in the field of digital logic. First it was the low-frequency RTL logic family that got all the attention, then DTL, TTL, Schottky TTL, ECL and cmos — each family offering more speed or less power consumption than the last. Now IBM researchers have developed a silicon structure that creates a vacuum-tube triode in silicon. Well, not exactly — but the new device has the same space-charge-limited current flow that occurs between the cathode and the plate in a vacuum tube. The value of this achievement is that it is now possible to build very low-power logic that operates in the 10- to 100-MHz region.

This new logic, which is called SCL (for space-charge-limited), outperforms all other logic, power-wise, at switching rates over 1 MHz. Cmos circuits, while low-power kings at the lower frequencies, require more power than SCL devices at

frequencies above 1 MHz. There is also a good possibility that these new SCL devices will be very attractive for low-level linear amplifiers. When operated at starved collector current levels of less than one microampere, SCL devices have shown current gains as high as 100,000. Furthermore, SCL devices theoretically should have all the low-noise performance of vacuum tubes because they have the same built-in noise cancellation that comes with space-charge-limited current flow. SCL semiconductors, of course, will be free of the heater noise that makes building low-noise vacuum tubes such a problem.

In an SCL device the space-charge-limited current flow takes place in the silicon substrate *under* a conventional lateral transistor which is located on the surface of the chip. The emitter, base and collector, in addition to providing connections to the device, provide the biases which form the operating fields that turn the n-type substrate into an SCL. The positive bias between the surface emitter and collector provide the cathode-plate potential (although only a fraction of a volt as compared to hundreds of volts in a vacuum tube, the principle is the same). The bias on the surface base creates a grid that controls the current between the cathode and plate. When the base is unbiased, a deep depletion region extends down into the silicon chip, virtually cutting off current flow. When the base is forward biased, the depletion region shrinks, allowing current to flow. The surface transistor, while notoriously slow, is never biased completely on, so it does not affect the speed of the SCL.

Jim Fisk, W1DTY
editor-in-chief



**Small Super Mast
in a big way.**

For the low profile Ham operator.

It had to happen! The enormous success of Tri-Ex's original Sky Needle—by popular demand—has brought about the design of a miniature Sky Needle for the Tri-Band Beam. We call it **Super Mast**.

It's a special tower for the low profile HAM operator. A roof-topper stretching to 40-feet up. Attaches easily, simply to the side of your garage, or house. A super-easy **Super Mast**.

A top-quality Tri-Ex product. Hot dipped galvanized

after fabrication for long life. A slim, clean-line tower. Tops in performance—**Super Mast**.

Shown here in its nested position at 21-feet, this **Super Mast** is supporting a three element 15 meter antenna & rotor assembly. Rush your order now. Visit or call your local Tri-Ex Tower dealer today. Price of this under-\$300-tower, because of rising steel costs, is subject to immediate change.

Tri-Ex® **TOWER CORPORATION** Order now and save!

7182 Rasmussen Avenue, Visalia, Calif. 93277

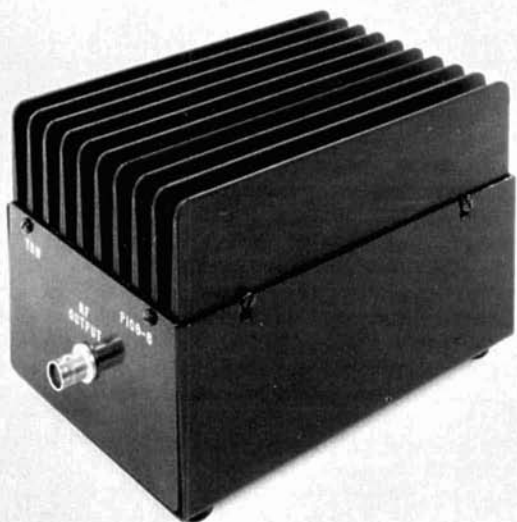

high-power solid-state linear power amplifier

Complete construction
details for a
broadband linear with
320 watts output —
including details on
combining four
basic amplifiers
to build a
solid-state kilowatt

Steve Chambers, Applications Engineer, TRW

Chances are, when you think of building a high-power, high-frequency linear rf power amplifier, you immediately think of using vacuum tubes. There has long been a need for high powered, solid-state rf amplifiers that offer highly reliable broadband operation, reducing the need for regular preventative maintenance. However, the achievement of such solid-state linear power amplifier (LPA) designs has been inhibited by the limitations of available transistors. Until recently they had low output power levels, required elaborate temperature compensation schemes and required precise power output control during conditions of high load vswr.

Several months ago, however, TRW Semiconductors introduced a new transistor developed for linear high-frequency ssb operation that is tolerant of mismatch, overdrive and wide temperature variations. This device is the TRW PT6665A/PT5788, rated at 100 watts,

either peak envelope power or CW. The PT6665A is in a flange-mounted package while the PT5788 is the stud-mounted version. These devices, in small quantities,

1000-watts *output* with only three of the basic amplifiers, IMD performance is reduced slightly, particularly at the upper power levels.

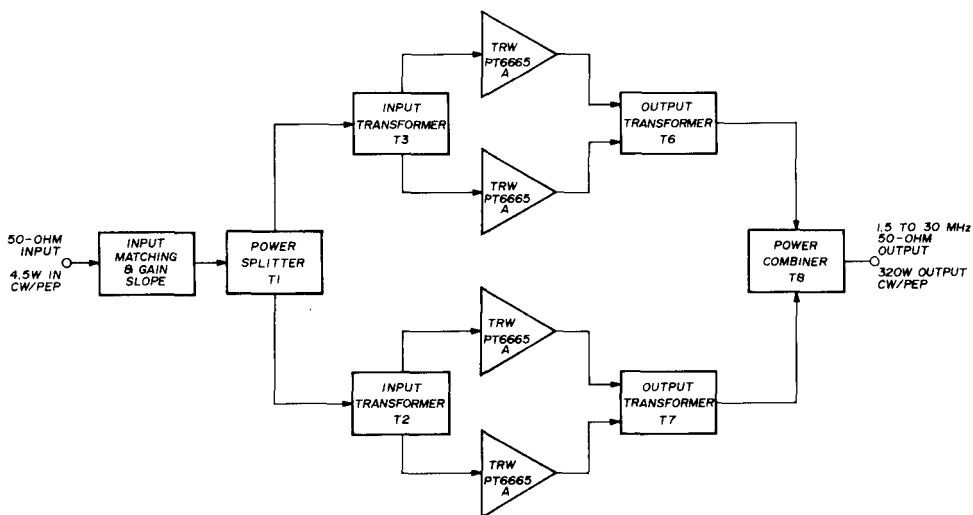

fig. 1. Block diagram for the broadband solid-state 320-watt rf power amplifier that covers the frequency range from 1.5 to 30 MHz.

cost about \$36.00 each. When you consider the simplicity of the design and the lack of expensive high-voltage components (and a high-voltage power supply), this is quite reasonable. However, you do have to provide a rather husky 28-volt dc supply.

This article shows how to build a 320-watt (output) linear power amplifier using four TRW PT6665As in a two push-pull pair configuration. The broadband amplifier operates directly from a 28-volt dc source and covers the frequency range from 1.5 to 30 MHz without tuning. Four of these basic power amplifiers can be combined through summing networks, as will be discussed later, to build a conservative 1000-watt linear. Although it is possible to obtain

The 320-watt linear amplifier shown in block form in fig. 1 has a power gain of about 17 dB. As can be seen from fig. 2, 4.5 watts of drive power is all that is required for full power output at 30 MHz; less than two watts of drive is required for full rated output on 160 meters. This amplifier is capable of withstanding open- and short-circuit load conditions at full power output and the intermodulation distortion (IMD) is better than -32 dB. If power output is held to 250 watts, the IMD performance is better than -35 dB as plotted in fig. 3.* This is better than many vacuum

*IMD referenced to either of two equal tones as is standard amateur practice. IMD must be increased 6 dB for reference to peak power, or increased 3 dB for average power reference.

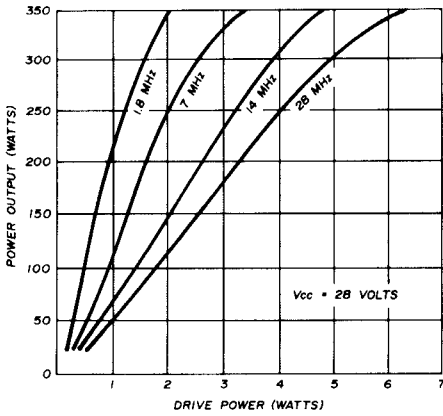

fig. 2. Drive requirements for the 320-watt power amplifier.

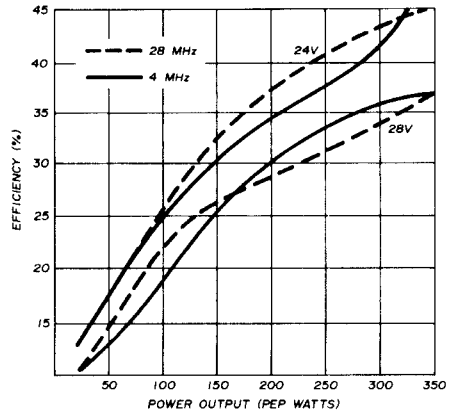

fig. 5. Gain and efficiency of the 320-watt linear amplifier vs supply voltage.

tubes, particularly the TV sweep tubes that are often used in amateur service at this power level. The affect of quiescent (idling) collector current upon IMD is shown graphically in fig. 4. Gain and efficiency of the amplifier are shown in fig. 5.

circuit

Since class-B or -AB linear amplifiers are linear only with regard to their power-transfer characteristics, the output signal contains harmonics that are a function of the ratio of the cutoff frequency to the operating frequency and to the selectivity of the output matching network. This indicates that the power transistors be operated push-pull. With this arrangement, 40-dB rejection of the even-order harmonics is readily achieved, and the odd-order harmonics can be easily filtered. To achieve the goal of 320 watts *output* in this amplifier, two pairs of TRW PT6665A transistors are operated in push-pull and their outputs are combined in a zero-degree hybrid transformer (T8) as shown in fig. 6.

The input drive to the amplifier is divided equally between the two push-pull stages by the power splitter, T1, another zero-degree hybrid transformer. These transformers convert the 50-ohm source and load impedances into two 100-ohm parts which are in phase. Any

With this arrangement, 40-dB rejection of the even-order harmonics is readily achieved, and the odd-order harmonics can be easily filtered. To achieve the goal of 320 watts *output* in this amplifier, two pairs of TRW PT6665A transistors are operated in push-pull and their outputs are combined in a zero-degree hybrid transformer (T8) as shown in fig. 6.

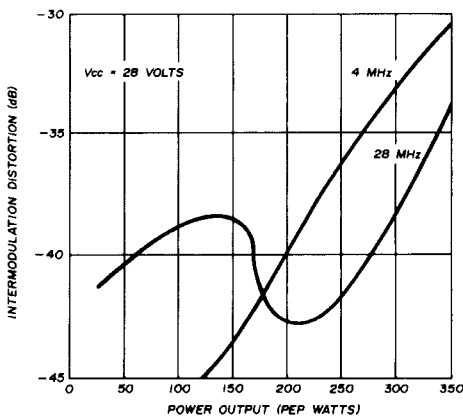

fig. 3. Intermodulation distortion of the solid-state linear amplifier at various power levels.

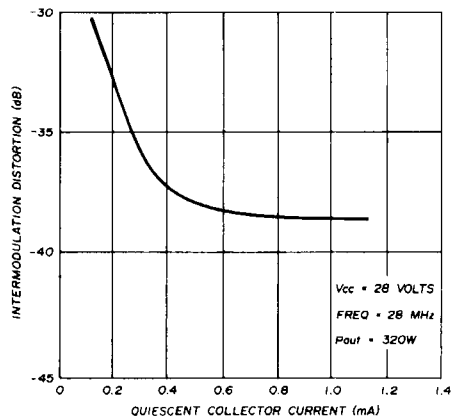

fig. 4. Affect of quiescent (idling) collector current upon intermodulation distortion.

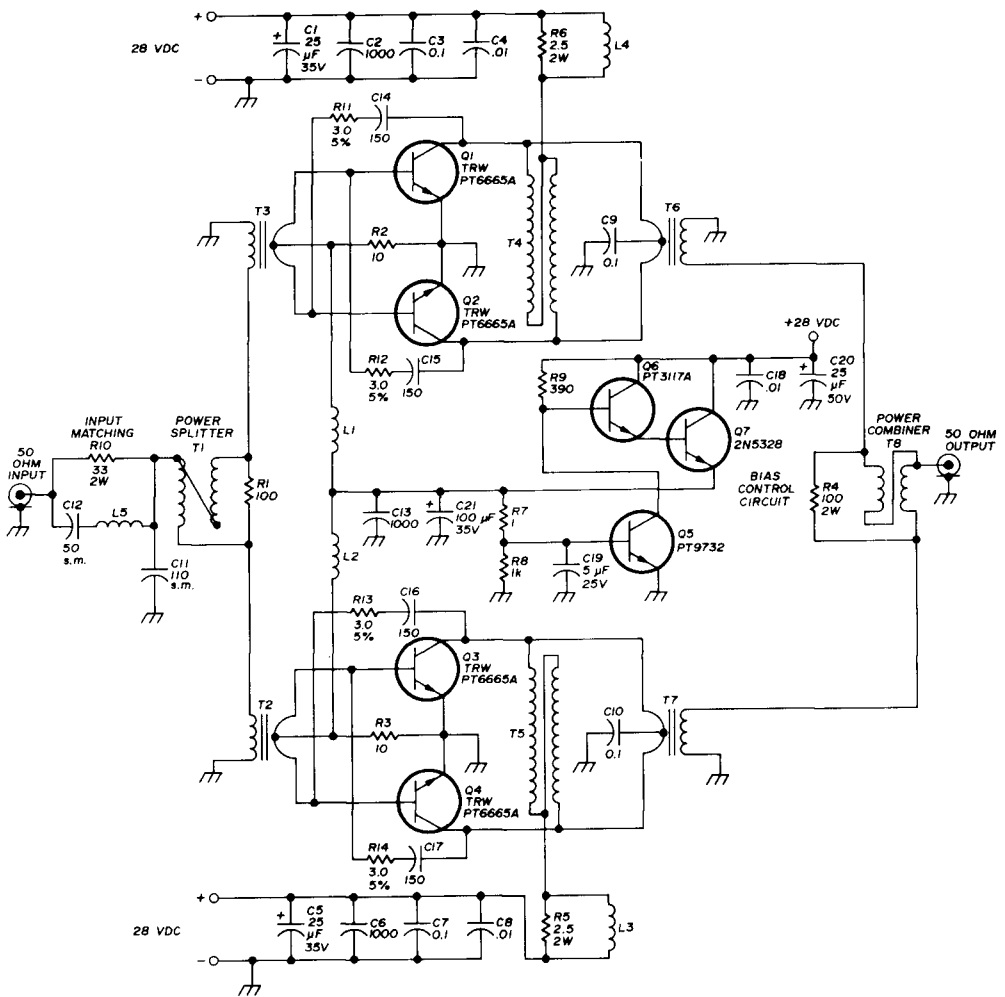
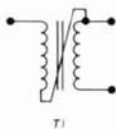

fig. 6. Schematic diagram of the solid-state 320-watt linear power amplifier. Complete construction details for the transformers are shown in figs. 7 and 8. All resistors are 1/2-watt unless otherwise noted.

amplitude or phase unbalance causes power to be dumped into resistors R1 and R4. The input impedance of the amplifier is near 50 ohms on 160 through 15 meters, going up slightly, to 75 ohms, on 10 meters:

1.8 MHz	50 + j3.5 ohms
3.5 MHz	49 + j1.0 ohms
7.0 MHz	48 + j1.3 ohms
14.0 MHz	49 + j3.2 ohms
21.0 MHz	55 + j10 ohms
28.0 MHz	70 + j2.5 ohms
30.0 MHz	75 + j0 ohms

- C1, C5 25- μ F, 35-volt electrolytic
- C2, C6 1000 pF metal clad (Underwood Electric type J-101)
- C13 150-pF metal clad (Underwood Electric type J-101)
- C14, C15 150-pF metal clad (Underwood Electric type J-101)
- C16, C17 5- μ F, 25-volt electrolytic
- C19 25- μ F, 50-volt electrolytic
- C20 100- μ F, 35-volt electrolytic
- C21 5- μ F, 25V
- L1, L2 5 turns no. 20 enameled on one Fair-Rite CN20 ferrite bead (available from Amidon Associates)
- L3, L4 0.56- μ H molded inductor
- L5 TRW type PT6665A
- Q1, Q2 TRW PT9732 (thermally connected to heatsink)
- Q3, Q4 TRW PT3117A (200 mA transistor)
- Q5 TRW 2N5328 (2 amp transistor)
- Q6 2.5 ohms (four 10-ohm, 1/2-watt resistors in parallel)
- Q7 2.5 ohms (four 10-ohm, 1/2-watt resistors in parallel)
- R5, R6 2.5 ohms (four 10-ohm, 1/2-watt resistors in parallel)



T1
Twisted pair no. 18 wire, 5 twists per inch (not critical), wound through two rows of CN-20 ferrite beads, 3 beads per row.

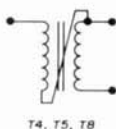

T4, T5, T8
Twisted pair no. 18 wire, 5 twists per inch (not critical), wound through two rows of CN-20 ferrite beads, 12 beads per row.

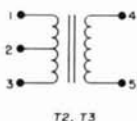

T2, T3
Terminals 1 and 3: One turn consisting of two pieces brass tubing, 0.190" (5 mm) OD, 8.80" (20 mm) long, each piece of tubing threaded through 3 CN-20 ferrite beads. Terminals 4 and 5: 3 turns no. 18 enamelled wire, wound through centers of brass tubing.

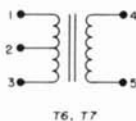

T6, T7
Terminals 2 and 3: One turn consisting of two pieces brass tubing, 0.190" (5 mm) OD, 2.50" (64 mm) long, each piece of tubing threaded through 12 CN-20 ferrite beads. Terminals 4 and 5: 4 turns no. 18 enamelled wire, wound through centers of brass tubing.

fig. 7. Winding details for transformers T1 through T8. All ferrite beads are Fair-Rite type CN-20 (No. 2643002401), length = 0.190" (5 mm), OD = 0.380" (10 mm), ID = 0.190" (5 mm). The completed transformer assembly is shown in fig. 8. The CN-20 beads are available from Amidon Associates, 12033 Otsego Street, North Hollywood, California 91607; 144 beads, \$13.00.

fig. 8. Construction of the combiner transformers T4, T5, T6, T7 and T8. Transformer T8 is wound through two rows of ferrite beads in center; T5 is wound through two rows of beads and is mounted above T7 (left), transformer T4 is mounted above T6 (right). Complete winding details are given in fig. 7. Inductors L4 and L5 are to the right next to resistors R5 and R6 (see fig. 11).

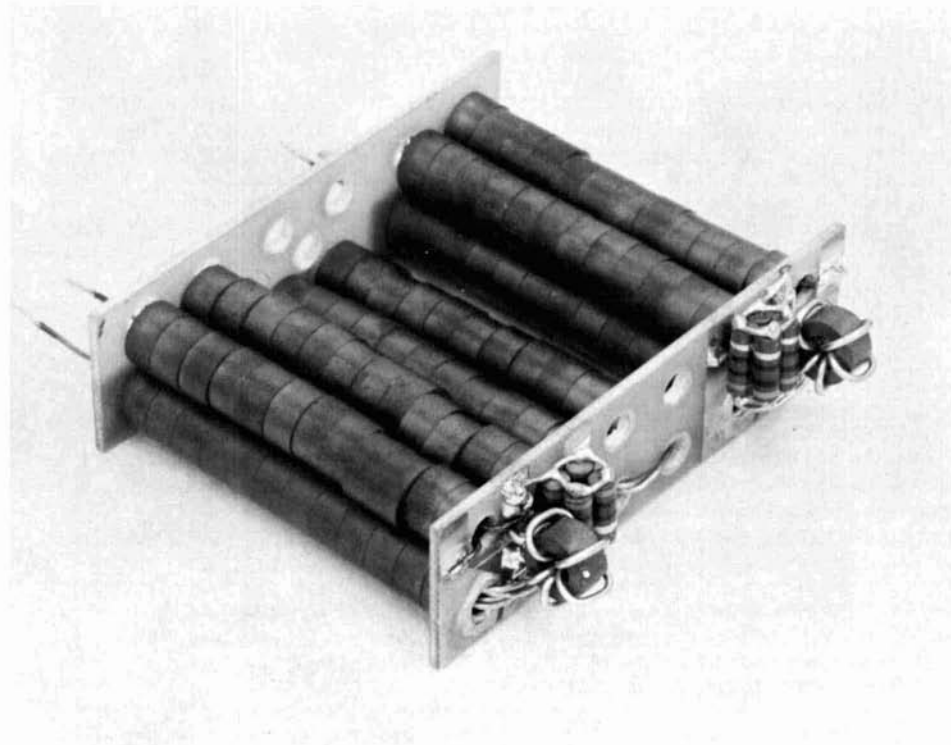

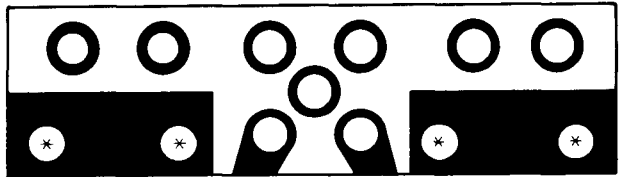

A TWO REQUIRED

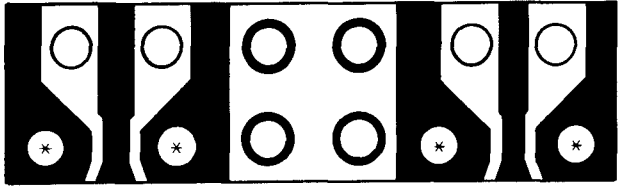

B ONE REQUIRED - T1, T2, T3

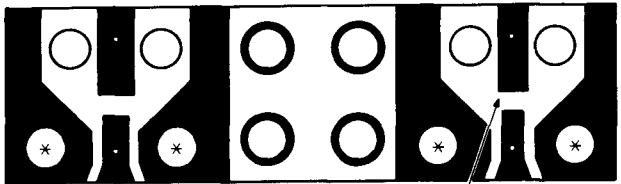

C ONE REQUIRED - T4, T5

CUT OUT FOR R6-L4 AND R5-L3

fig. 9. Printed-circuit board for the combiner transformers uses single copper-clad board. Two pairs of boards are required for the amplifier. The 0.190" (5 mm) OD brass tubing is soldered in the holes marked with an asterisk.

Transformers T2, T3, T6 and T7 each employ two ferrite-loaded brass tubes which form a center-tapped, U-shaped winding. The high-impedance winding is threaded, in continuous turns, through the brass tubing until the desired turns ratio is achieved. Winding and construction details for these transformers are shown in fig. 7 and 8.

The required turns ratio for the input transformer, T1, is determined by:

$$\frac{N1}{N2} = \sqrt{\frac{Z_{in}}{Z_{nom}}}$$

where Z_{in} = summing port impedance (100 ohms)

$$Z_{nom} = \sqrt{Z_{LF} Z_{HF}}$$

The quantities Z_{LF} and Z_{HF} are the complex input impedance of the transistors at the low- and high-frequency extremes, respectively. For the TRW PT6665A/PT5788, these values are:

1.5 MHz: $Z_{LF} = 8.1 - j8 \approx |11.38|$ ohms
 30 MHz: $Z_{HF} = 2.0 + j2 \approx |2.83|$ ohms

Therefore, $Z_{nom} = 5.67$ ohms and the required turns ratio for the input transformer is:

$$\frac{N1}{N2} = \sqrt{\frac{100}{5.67}} = 4.2$$

The turns ratio for the collector transformer is determined by the following equation:

$$\frac{N1}{N2} = \sqrt{\frac{Z_L P_o}{2(V_{cc} - V_{sat})^2}}$$

- where: Z_L = summing port impedance (100 ohms)
 P_o = combined output power for the pair of transistors (200 watts)
 V_{cc} = collector supply voltage (28 volts)
 V_{sat} = rf saturation voltage (1.5 volts)

For this amplifier,

$$\frac{N1'}{N2'} = \sqrt{\frac{100 \times 200}{2(28 - 1.5)^2}} = 3.8$$

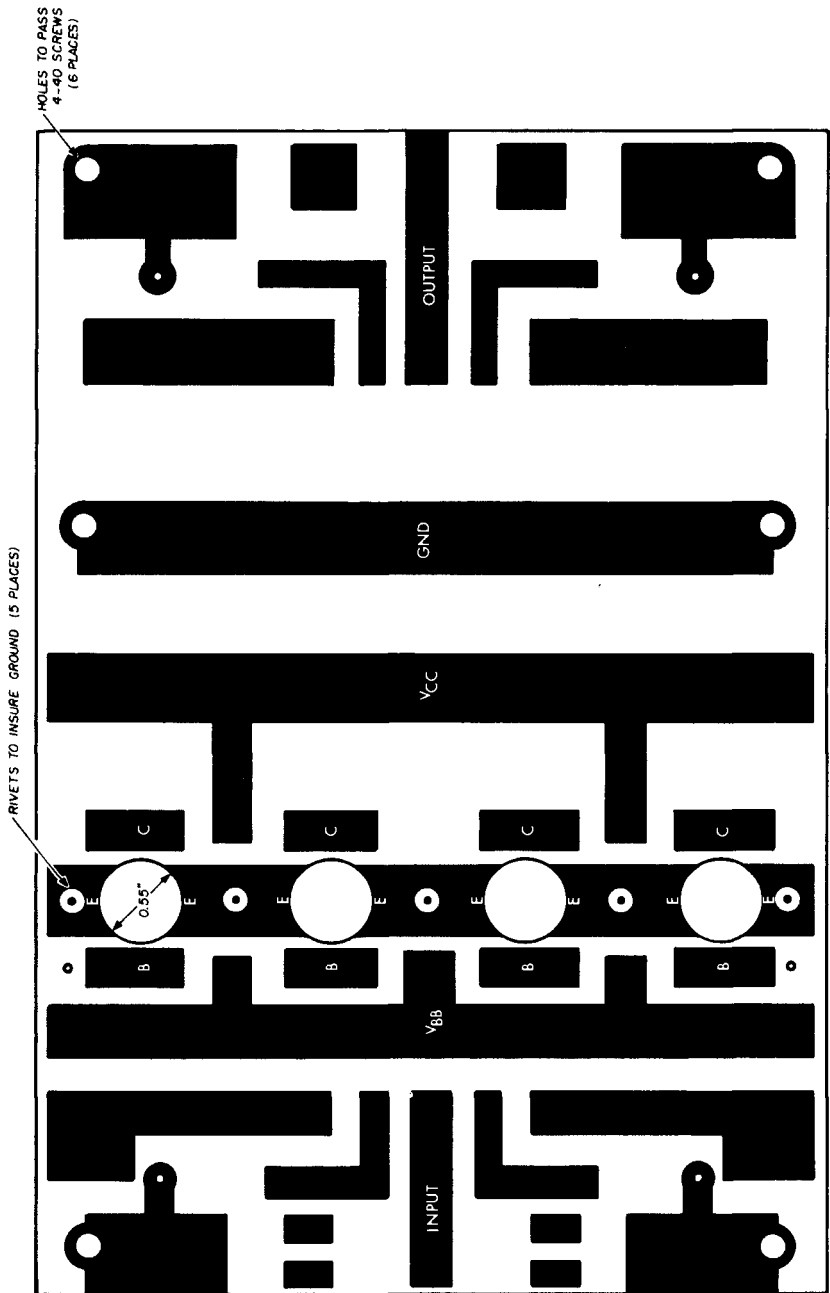

fig. 10. Full-size printed-circuit layout for the 320-watt power amplifier. Parts placement is shown in figs. 11 and 12.

The output transformer chosen for the amplifier uses the calculated turns ratio. However, for the input transformer a 3:1

ratio was used in place of the calculated 4.2:1 because it improves the match at 28 MHz. The gain-vs-frequency response and

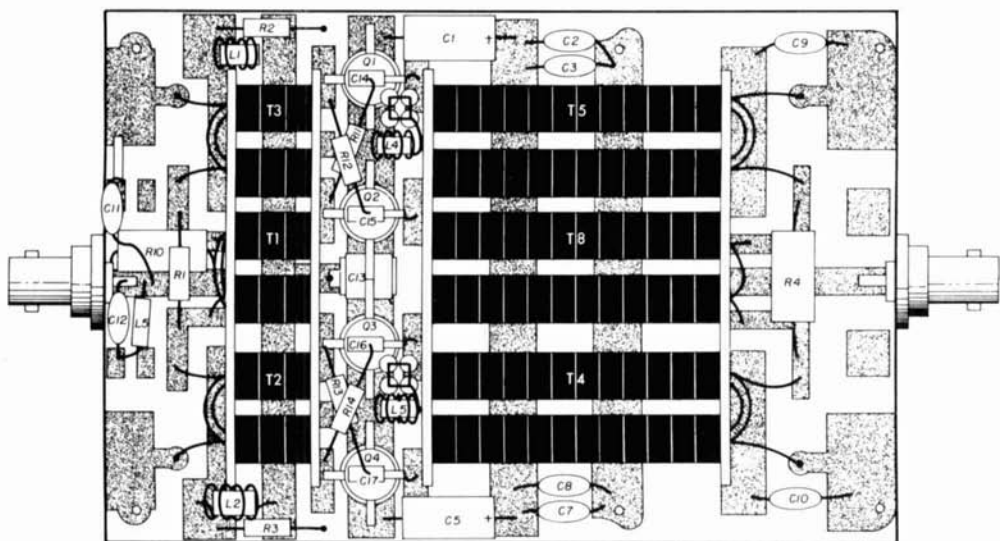

fig. 11. Component layout for the rf power amplifier. Transformer T6 is underneath T4, T7 is underneath T5.

the input impedance match have been further tailored by the addition of C11, C12, L5 and R10 at the amplifier input.

The collector feed transformers (T4

and T5) combine with the output matching transformers to form a modified 180-degree hybrid combiner as described by Pitzalis and others.¹ The ferrite mate-

fig. 12. Completed 320-watt linear power amplifier, showing location of the power transistors, combiner transformers and other components. In this photograph the input is to the left, output is to the right (see fig. 11).

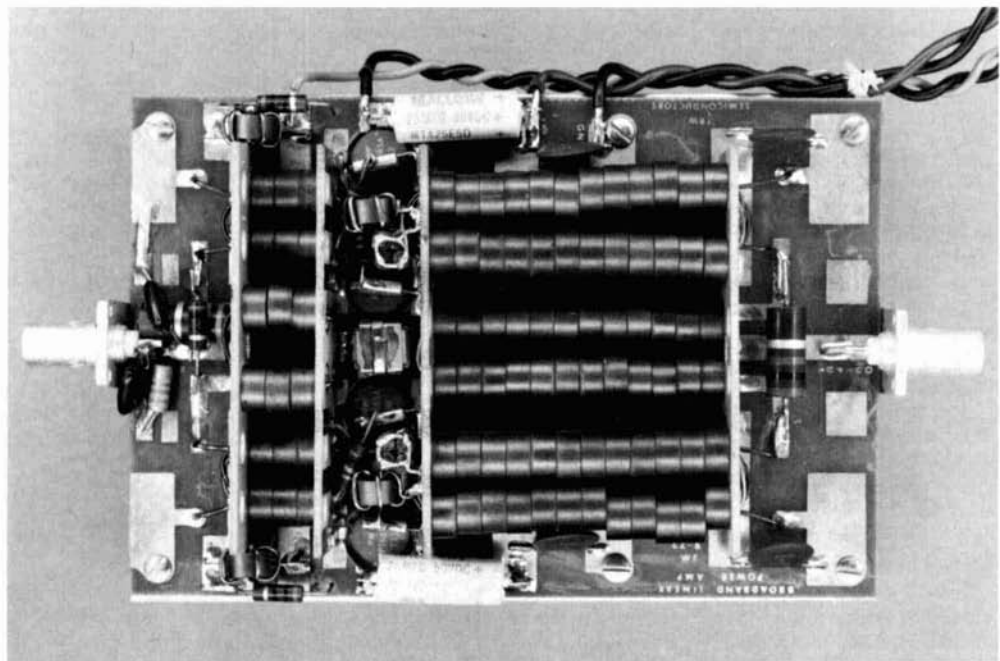

rial used must have an initial permeability of 800 and the permeability must remain above 200 at 30 MHz. Losses in this ferrite are quite low and the ferrite temperature used is typically less than 20°C at full CW output. The Curie temperature is 150°C minimum (165°C typical).

When winding the transformers, care must be taken to avoid scraping insulation from the wire. Any burrs should be removed from inside the brass tubing and a heavy varnished Formvar-type wire should be used. Do not use thermal strip-away wire because it may break down and short out under high-power rf loads.

The bias control circuit used in the amplifier is of the temperature-tracking, fixed-current type (transistors Q5, Q6 and Q7). The temperature sensing transistor, Q5 (TRW PT9732), is mounted on the heatsink as close as possible to the center of the mounting area of the rf power transistors Q1, Q2, Q3 and Q4.

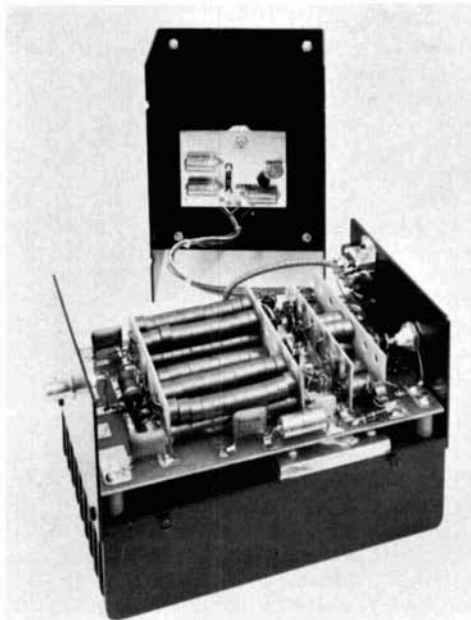

Complete 320-watt solid-state linear showing printed-circuit board installed on heatsink. Circuitry on small board mounted on cover is part of the bias-control circuit.

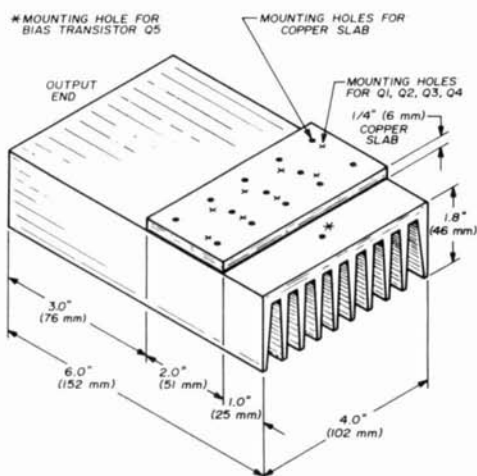

fig. 13. Heatsink and copper slab hole patterns. The heatsink is a Thermalloy 6157 or similar. All holes in the copper are drilled to pass a 4-40 screw; all holes in the aluminum are drilled and tapped for 4-40 screws. The printed-circuit mounting holes should be located after the PC board is drilled.

construction

The printed-circuit board for the 320-watt linear amplifier is shown in fig. 10. Parts placement is shown in fig. 11. This drawing also contains information on the location of the power supply filter

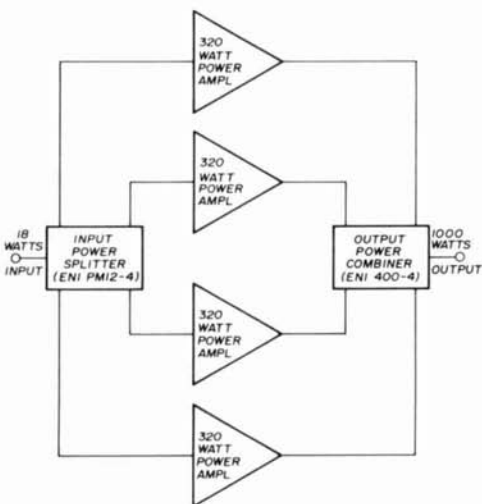

fig. 14. Four of the 320-watt amplifiers can be combined, as shown here, to provide 1000 watts output over the frequency range from 1.5 to 30 MHz. IMD and drive power for this arrangement are plotted in figs. 15 and 16.

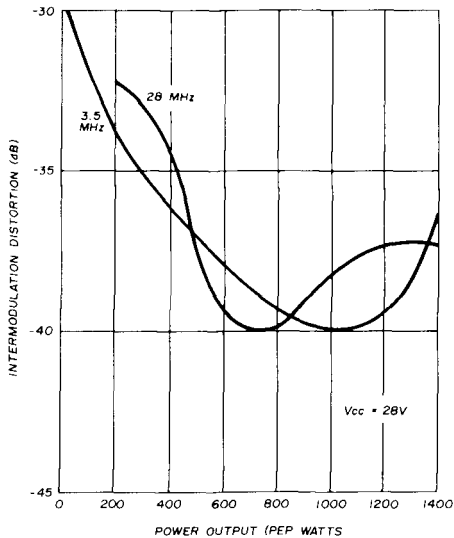

fig. 15. IMD performance of the 1000-watt linear amplifier.

components L4/R6 and L3/R5. The location of the collector-to-base feedback networks—C14/R11, C15/R12, C16/R13, C17/R14—can be easily determined from the photographs. Capacitors C2 and C6 (not visible in fig. 12) are located on the ground strip. Capacitor C2 is between Q1 and Q2, and C6 is between Q3 and Q4.

Since considerable heat is dissipated by the power transistors, good thermal conductivity between the transistors and the heatsink must be insured. This is accomplished by:

1. Placing a piece of slab copper between the transistor flange and the aluminum heatsink (see fig. 13).
2. Sanding smooth the copper slab and the heatsink surface as well as the bottom of the transistor flange.
3. Using thermal conductive compound between the copper slab and heatsink and between the transistor flanges and the copper.
4. Using cooling air for long transmission periods.

*Available from Electronic Navigation Industries, Inc., 3000 Winton Road South, Rochester, New York 14623.

solid-state kilowatt

To obtain a very conservative 1000-watts rf output over the frequency range from 1.5 to 30 MHz, four of the 320-watt amplifiers can be combined using straightforward, commercially available summing circuitry as shown in fig. 14. The input power splitter, an ENI model PM12-4, and the output power combiner, an ENI model 400-4, are available from Electronic Navigation Industries.* The overall amplifier operates directly from a 28-volt dc power supply with a typical IMD of -36 to -38 dB at full rated output. Although IMD performance falls off at lower power levels, it is better than -30 dB for all cases (see fig. 15).

The drive requirements for the 1000-watt amplifier, plotted graphically in fig. 16, vary from approximately 4.5 watts at 3.5 MHz to 18 watts at 28 MHz. As noted previously, a 1000-watt amplifier can also be built with three of the basic 320-watt power amplifiers, but with some increase of IMD harmonics, to -30 dB or so, at the upper power levels.

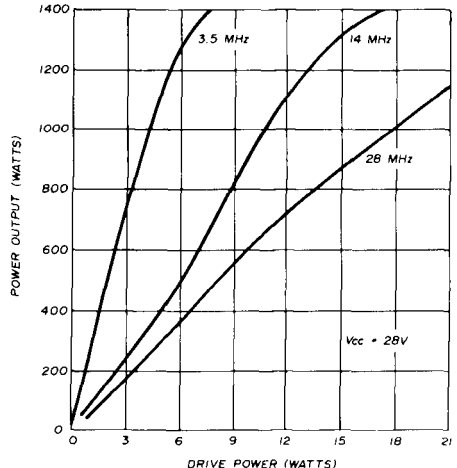

fig. 16. Drive requirements for the broadband, 1000-watt linear amplifier.

reference

1. O. Pitzalis, Jr., and T. Couse, "Broadband Transformer Design for RF Transistor Power Amplifiers," U.S. Army Electronics Command, Fort Monmouth, New Jersey

ham radio

how to calculate wind loading

on towers and antenna structures

A discussion
of the effect
of wind loading on
self-supporting towers,
guyed towers
and other
antenna structures

John J. Nagle, K4KJ, 12330 Lawyers Road, Herndon, Virginia 22070

Almost all amateur operators are involved at one time or another in the erection of an antenna tower. The construction of a tower to withstand the elements, most notably wind, is of prime importance to the successful operation of an amateur station. Yet, very few amateurs bother to calculate the wind forces, or wind loading as it is technically known, on their antennas or towers. This may be because there is very little material on this subject available in the amateur literature.

Wind loading is generally considered to be a civil engineering subject and therefore not suitable for an electronic engineering publication, but when properly organized, the subject is relatively straight forward, requiring at most a knowledge of high school physics. Actually, I have seen subjects that are much more complex, both physically and mathematically, successfully treated in *ham radio* and similar magazines.

The purpose of this article is to organize and present the subject of wind loading on radio towers in such a manner that the average amateur who has the skill and ability to assemble and operate an amateur station can calculate the wind forces trying to overturn his tower. The wind loading on parabolic antennas and

the use of guy wires will also be briefly discussed.

Much of the material in this article has been taken from Electronic Industries Association (EIA) Standard RS-222-B, dated December, 1972.¹ I highly recommend that anyone planning to construct an antenna system obtain a copy of this standard as it is easy reading and contains much interesting and useful information beyond what will be presented here.

Calculating the wind loading on an antenna is a relatively simple procedure: First, determine the projected area of the tower and antenna. Then, by applying a very simple formula the area can be converted into a horizontal force for any wind velocity. For a free-standing (unguyed) tower which is constrained only at the base, this horizontal force develops an overturning moment which the tower and foundation must resist. The situation for a guyed tower which is constrained at both top and bottom is slightly different in that tensions in the guy wires must also be calculated; these will also be considered. These calculations are all very simple and will be discussed using examples.

projected area

For the tower and beam example, I will use a forty-foot (12.2-meter) tower made of four ten-foot (3-meter) sections with a 20-meter beam on the top; this is typical of installations used by amateurs. A typical 10-foot (3-meter) section is shown in fig. 1; as can be seen, the tower has a triangular cross-section with six sets of cross braces per side. The main structural members are at the corners and are composed of 1½-inch (3.2-cm) OD steel tubing; the cross-bracing consists of 3/8-inch (10-mm) OD rod, each rod 12-inches (30.5-cm) long.

The projected area of each corner leg is therefore $1\frac{1}{2} \times 120 = 150$ square inches ($3.2 \times 304.8 = 975.4$ square cm). Since there are two legs per face

$$2 \times 150 = 300 \text{ square inches}$$

$$2 \times 975.4 = 1950.8 \text{ square cm}$$

For the cross-braces we have

$$0.375 \times 12 \times 2 = 9 \text{ square inches}$$

$$0.95 \times 30.5 \times 2 = 58 \text{ square cm}$$

As there are six sets of braces per ten-foot (3-meter) section

$$6 \times 9 = 54 \text{ square inches}$$

$$6 \times 58 = 348 \text{ square cm}$$

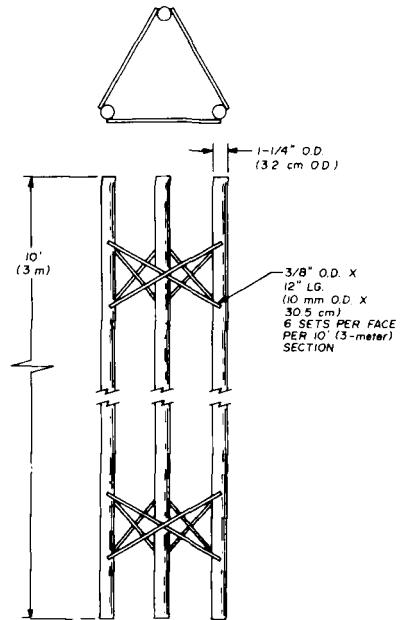

fig. 1. Dimensions of a typical 10-foot triangular tower section.

Hence, the total surface area is

$$300 + 54 = 354 \text{ square inches}$$

$$1936 + 348 = 2284 \text{ square cm}$$

This is equal to $(354/144) = 2.46$ square feet (0.228 square meters) per ten-foot (3-meter) section, as there are 144 square inches per square foot.

It is important to notice that we did not calculate the surface area of the cylindrical structural members, but instead calculated the projected area. The projected area may be defined as the outline area or as the area of a shadow cast by the member. If the structural member has a flat surface, such as a

wooden 2x4 or steel angle-iron, the projected area and surface area will be the same, but this is not the case for structural members with a cylindrical cross-section.

The reason for using the projected area can be explained as follows: When a cylindrical surface has a uniform pressure applied as shown in **fig. 2**, the components applied close to the tangential points, such as vectors A and C, exert a relatively small component on the cylinder parallel to their own direction. The radial components that they exert are equal and opposite and, hence, cancel out. The components applied at the center, such as vector B, are fully effective

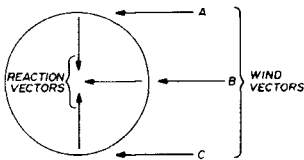

fig. 2. Diagram of wind and reaction vectors on a cylindrical surface.

in creating horizontal force on the structural member. It can be shown mathematically that the wind resistance is proportional to the projected area and not the surface area.

In the case of a cylinder the wind force is further reduced because the streamlining effect of the cylinder makes the wind force less than for a flat surface of the same projected area. Paragraph 2.2.4 of reference 1 states that, "the pressure on cylindrical surfaces shall be computed as being 0.66 of that specified for flat surfaces." This means that when dealing with cylindrical structural members, the wind forces are two-thirds those of flat surfaces, or to say the same thing in a different manner, the projected area of the cylindrical member may be reduced to 0.66 of its actual value.

In the case of open face or lattice towers, one other factor must be considered. That is the effect of wind blowing through the tower and against the back structural elements as this area is

also effective in developing a horizontal force. Paragraph 2.2.5 of reference 1 states that,

"For open face (latticed) structures of square cross section, the wind pressure shall be applied to 1.75 times the normal projected area of all members in one face. For open face (latticed) structures of triangular cross section, the wind pressure shall be applied to 1.5 times the normal projected area of all members in one face. For closed face (solid) structures, the wind pressure shall be applied to 1.0 times the normal projected area."

The only type of solid structures I can think of that would be used by amateurs are irrigation tubing, telephone poles or wooden 2x4s bolted together.

It can be noted when dealing with lattice-type towers with a triangular cross section, and using the cylindrical structural members which are so popular in amateur work, the 1.5 triangular factor, when multiplied by the 0.66 cylindrical factor, gives $0.66 \times 1.5 = 1$. Therefore, both factors can be neglected when dealing with this type of tower. Although these factors may be neglected, they should not be forgotten!

wind force

So much for area involved. The problem now is to convert that area into a force. EIA Standard RS-222-B states in paragraph 2.3 that the wind pressure P in pounds per square foot is given by

$$P = 0.004 V^2 \quad (1)$$

where V is the wind velocity in miles per hour and 0.004 is the wind conversion factor (includes a gust factor and a drag coefficient for flat surfaces).* Note that the wind force is proportional to the wind velocity squared.

It may be pointed out that the exponent on the velocity, 2 in this case, is itself a function of the velocity. The

*In metric terms the formula is $P = 0.0075 V^2$, where P is in kilograms per square meter and V is velocity in kilometers per hour.

factor 2 is a good average value for wind velocities in, say, the 30- to 100-mph (48- to 161-kph) region. For extremely low velocities, say, less than about 10-mph (16 kph), wind force is linear with velocity. As wind velocity approaches the trans-sonic region, the exponent becomes very high. This is why supersonic aircraft require such large engines.

It is interesting to digress for a moment and consider eq. 1 in a different light. By applying Newton's third law (action and reaction), eq. 1 also gives the wind resistance when an object is driven at a given velocity through still air. For example, a standard size automobile presents a frontal area of about 25 square

since we have calculated the projected area, this can be converted to a horizontal force at any given velocity by using eq. 1. The only question remaining is what wind velocity to design for. Fortunately, RS-222-B comes to our aid again. Table 1 and the accompanying map of fig. 3 give the recommended horizontal design wind pressures in pounds per square foot and kilograms per square meter for various parts of the United States (windloading zones) and for various heights above ground. RS-222-B also has a table giving the zones by states and counties, which will not be reproduced here because of space limitations. If you cannot pinpoint your location precisely from fig. 3, you

table 1. Recommended horizontal design wind pressures in pounds per square foot (kilograms per square meter given in parenthesis). Wind-loading zones for the United States are shown in fig. 3.

height zone (above ground)	wind-loading zone		
	A	B	C
Portion of tower 300 feet (91.4 meters) and under	30 (146.5)	40 (195.3)	50 (244.1)
Portion of tower 301 to 650 feet (91.7 to 198 meters)	35 (170.9)	48 (234.3)	60 (292.9)
Towers 651 feet (198.5 meters) and higher shall be designed for uniform wind pressure for their entire height	50 (244.1)	65 (317.3)	85 (415.0)

feet (2.3 square meters) so at 60 mph (96.6 kph) requires

$$P = 0.004 \times 60^2 \times 25 = 360 \text{ pounds of force}$$

$$P = 0.0075 \times 96.6^2 \times 2.3 = 161 \text{ kilograms of force}$$

just to overcome wind resistance. Note that increasing the velocity by $\sqrt{2} = 1.414$ (from 50 to 70 mph [80 to 113 kph], for example) will double the wind resistance. Couple this with the fact that the efficiency of a typical automobile engine is much less at 70 (113 kph) than at 50 mph (80 kph) — it's easy to see why fuel consumption increases astronomically at higher speeds.

wind-loading zones

Returning to our original problem,

may want to consult the table of counties in RS-222-B. You may also assume the more severe wind-loading zone.

The data for both table 1 and fig. 3 were obtained by statistical methods from long-term weather observations based on wind velocities that should not be exceeded, on the average, more than once every 50 years. The work is described in a paper by H.C.S. Thom.² A later paper on this same subject has also been published by Thom.³ Both Thom papers are highly statistical and the EIA map offers much more usable information for the average individual.

Most amateur towers will fall in the 300-foot-and-under (91.4 meters) category for which table 1 gives wind loading of 30, 40 or 50 pounds per square foot (146.5, 195.3 and 244.1 kg per square

meter) respectively, for wind zones A, B and C. Putting these numbers into eq. 1 gives wind velocities of 86.6, 100 and 112 miles per hour (139.4, 161 and 180 kilometers per hour). Since I live in the metropolitan Washington, D.C., area which is clearly in wind loading zone A, I

a total horizontal force of

$$(2.44 \text{ square feet}) \times (30 \text{ lb/sq ft}) \\ = 73.2 \text{ pounds, horizontal force}$$

$$(0.226 \text{ square meter}) \times (146.5 \text{ kg/m}^2) \\ = 33.2 \text{ kg, horizontal force,}$$

For later computational reasons we will

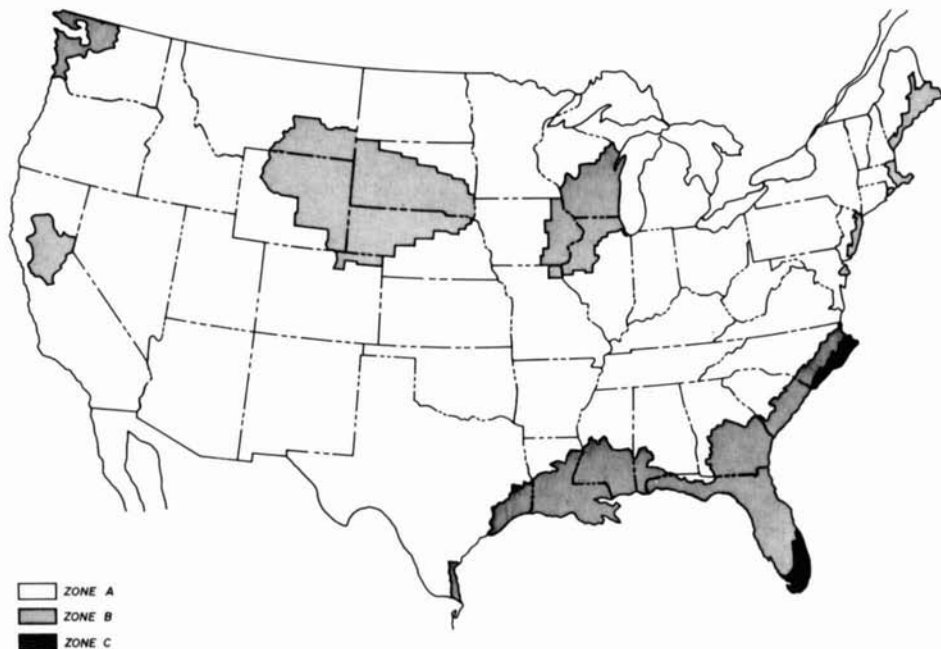

fig. 3. Location of wind-loading zones in the United States (from EIA Standard RS-222-B).

will design for wind loading of 30 pounds per square foot (146.5 kg per square meter) or 86.6 mph (139.4 kph).

practical example

Returning to the problem, we have already calculated that the projected area of a ten-foot (3-meter) section of tower is 2.46 square feet (0.228 square meter). Applying correction factors of 0.66 for cylindrical structural members and 1.5 for a triangular tower gives

$$2.46 \times 0.66 \times 1.5 = 2.44 \text{ square feet,} \\ (0.228 \times 0.66 \times 1.5 = 0.226 \text{ square meter) projected area}$$

Assuming a wind velocity of 86.6 mph (139.4 kph) (or 30 pounds per square foot [146.5 kg per square meter] — gives

assume this force is uniformly distributed along the length of the tower. This results in a loading of

$$\frac{73.2 \text{ lb}}{10 \text{ ft}} = 7.32 \text{ pounds per foot of tower}$$

$$\frac{33.2 \text{ kg}}{3 \text{ meters}} = 11.1 \text{ kg per meter of tower}$$

As previously stated, I intend to use four 10-foot (3-meter) sections to give the tower 40-feet (12.2-meters) height. This gives the situation shown in fig. 4 for a total horizontal force of

$$F = 40 \times 7.32 = 292.8 \text{ pounds}$$

$$F = 12.2 \times 11.1 = 135.4 \text{ kilograms}$$

Because the tower is constrained at the bottom and free at the top (unguyed), the effect of this force is to cause the

tower to rotate about the horizontal axis through its base, i.e. fall down.

In physics, a force that causes an object to rotate is called a *moment* or a torque and is defined as a force multiplied by a distance or

$$\text{moment} = \text{force} \times \text{distance} \quad (2)$$

The units are pound-feet (dyne-cm).

The problem now is, "How do we translate a uniformly distributed horizontal force into a single overturning moment?" Luckily, the answer is quite simple; a uniformly distributed force will generate the same moment as a single force with the same total value acting at a point midway on the structure. Hence a uniformly distributed force of 7.32 pounds/foot (11.1 kg/meter) along the tower will generate the same moment as a single force of 292.8 pounds (135.4 kilograms) acting at the mid-point of the tower. This is shown in fig. 5. This gives an overturning moment of

$$M = 20 \times 292.8 = 5856 \text{ pound-feet}$$

$$M = 6.1 \times 135.4 = 825.9 \text{ kilogram-meters } (8.2 \times 10^{10} \text{ dyne-cm})$$

This is the moment developed by the tower alone; now let's put a HyGain Model 203-BA three-element, 20-meter beam on the top of the tower which,

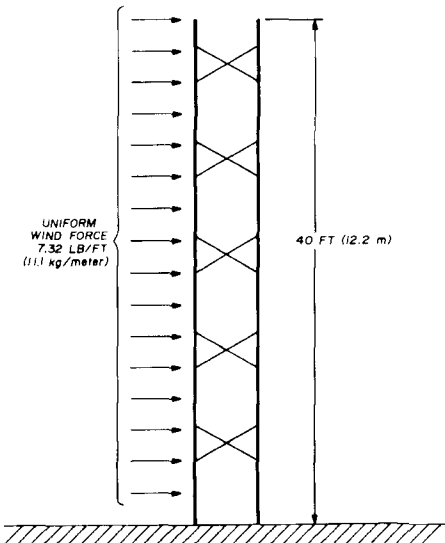

fig. 4. Uniform horizontal force on a tower.

according to the manufacturer, has an area of 3.08 square feet (0.286 square meter). A wind loading of 30 pounds per square foot (146.5 kg/m²) (86.6 mph – 139.4 kph) will develop a horizontal force of

$$(30 \text{ lb/ft}^2) \times (3.08 \text{ ft}^2) = 92.4 \text{ pounds}$$

$$(146.5 \text{ kg/m}^2) \times (0.286 \text{ m}^2) = 41.9 \text{ kilograms}$$

on the antenna which in turn will generate a moment of

$$M = 92.4 \times 40 = 3696 \text{ pound-feet}$$

$$M = 41.9 \times 12.2 = 511.2 \text{ kilogram-meters } (5.01 \times 10^{10} \text{ dyne-cm})$$

at the top of the tower. The total overturning moment acting on the tower is then

$$M = 3696 + 5856 = 9552 \text{ pound-feet}$$

$$M = 511.2 + 825.9 = 1337.1 \text{ kilogram-meters } (13.1 \times 10^{10} \text{ dyne-cm})$$

This combination is shown in fig. 6. This may be considered as a single force of 9552 pounds acting at a distance of one foot above the ground, a force of $9552/20 = 477.6$ pounds acting 20 feet up the tower, as a force of 238.8 pounds acting at the top of the tower, or any other combination of force multiplied by distance whose product is 9552 pound-feet as shown in fig. 6.

In metric terms, this may be considered as a single force of 1337.1 kilograms acting at a distance of one meter above the ground, a force of $1337.1/6.1 = 219.2$ kilograms operating 6.1 meters up the tower, as a force of 109.6 kilograms acting at the top of the tower, or any other combination of force multiplied by distance whose product is 1337.1 kilogram-meters.

The antenna and tower combination used in this example is relatively modest compared with some antennas, and yet, the overturning moment is nearly 5 tons on a one-foot arm!

The tower must be strong enough to transmit this moment to the foundation; the foundation, in turn, must be designed

to have a moment of its own that, when combined with the soil resistance, will resist this overturning moment with an acceptable margin of safety if the tower is to remain standing.

The design of tower structures themselves would take us into the subjects of structural mechanics and strength of materials; foundation design would add soil mechanics. These subjects are all well beyond the scope of this article. We will,

capable of supporting the guy wires. While very few amateurs are so fortunate, or unfortunate, as to have a 700-foot (213.4-meter) tower, the savings in material of a guyed tower is obvious.

A disadvantage of guyed towers is the additional real estate required for guy wires. In a commercial installation, the designer would compare the cost of real estate against the cost of additional steel and concrete required to make the tower

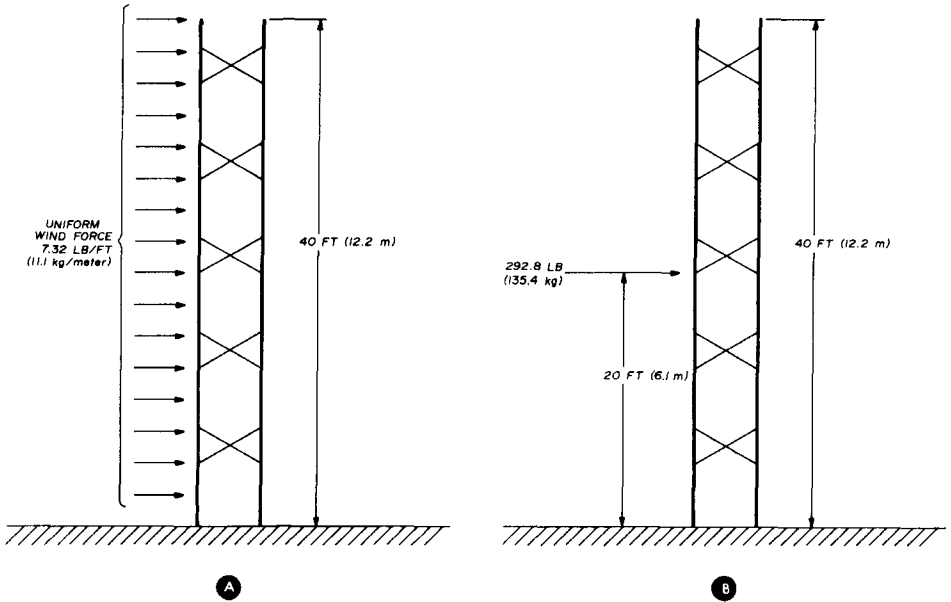

fig. 5. The overturning moment caused by the uniform wind force in (A) is exactly the same as the overturning moment generated by the single mid-tower force in (B).

however, briefly discuss guying since guy wires can significantly reduce foundation requirements.

guying

Guyed towers have the advantage of requiring much less structural material than self-supporting towers. As an example, a self-supporting 700-foot (213.4-meter) steel tower of conventional design will weigh about 460,000 pounds (208,651 kilograms). A comparable guyed tower will weigh about 200,000 pounds (90,718 kilograms) including the weight of the guys. It should be remembered that a guyed tower must also be

self-supporting. For the amateur who must install his tower in a residential neighborhood additional considerations are aesthetics and the whims of his wife. This last consideration, unhappily, is not amenable to a rigorous engineering analysis.

Assume now that the same 40-foot (12.2-meter) antenna and tower as previously described has a set of guy wires 30-feet (9.1-meters) from the base of the tower, as shown in fig. 7. From the Pythagorean theorem the length of the guy wire is

$$\sqrt{40^2 + 30^2} = 50 \text{ feet (15.2 meters)}$$

The angle with respect to ground is

$$\theta = \tan^{-1} \frac{40}{30} = 53.1 \text{ degrees}$$

For the sake of simplicity, we will consider only one guy wire. This is actually the case when the wind is blowing toward the tower from the direction in which the guy wire under consideration is anchored.

It is not generally appreciated, but a guy wire converts an overturning mo-

uniformly distributed over the length of the tower, we will assume that one-half the constraining force — 146.5 pounds (66.5 kg) — is located at the top of the tower and one-half at the bottom. The horizontal force on the antenna — 92 pounds (41.7 kg) — will be assumed to be located entirely at the top of the tower. This is shown in **fig. 8**.

This allocation of reactions given may seem arbitrary, but it is difficult to

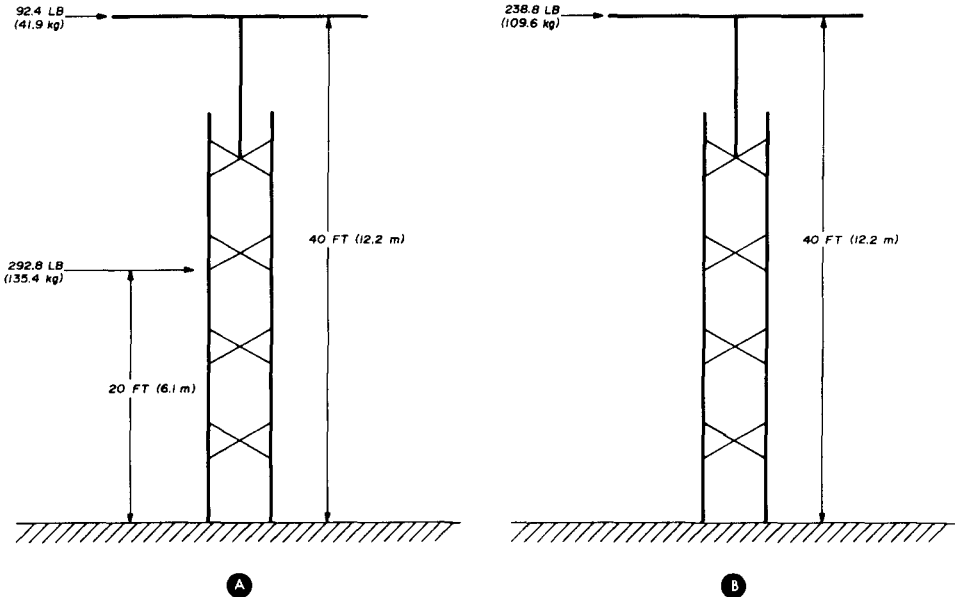

fig. 6. The overturning moment in (A) is the same as the overturning moment in (B). See text for calculations.

ment into increased downward stress on the tower. As previously noted, the total horizontal force in this example is 293 pounds (132.9 kilograms) on the tower plus 92 pounds (42 kilograms) on the antenna. Since the top of the tower is now constrained by the guy wires, the overturning moment is zero. For this reason the structural requirements on the tower and foundation are greatly reduced because these items need only support the weight of the assembly and the additional load imposed by tension in the guy wires.

Because the horizontal force on the tower — 293 pounds (132.9 kilograms)—is

visualize a mechanism by which the 92-pound (41.7-kilogram) horizontal force of the antenna can be transmitted to the base of the tower without generating a moment. Also, if there is any error, the forces in the guy wire will be overestimated and not underestimated. The tension in the guy wire may be resolved into a horizontal and a vertical component. The horizontal component must be 238.5 pounds (108.2 kilograms) since it must exactly equal the horizontal windload (146.5 + 92 pounds or 66.5 + 41.7 kilograms). The tension in the guy wire itself may be calculated by setting up a vector diagram as in **fig. 9**.

$$F_{gw} = \frac{238.5}{\sin 39.9^\circ} = 397.2 \text{ pounds}$$

$$F_{gw} = \frac{108.7}{\sin 36.9^\circ} = 181 \text{ kilograms}$$

where F_{gw} is the force on the guy wire and the additional vertical component which must be resisted by the tower is

$$F_v = \frac{238.5}{\tan 36.9^\circ} = 318 \text{ pounds}$$

$$F_v = \frac{108.2}{\tan 36.9^\circ} = 144.2 \text{ kilograms}$$

In other words, an 86.6-mph (139.4 kph) wind will develop a tension of 397.2 pounds (180.2 kilograms) in the guy wire and an additional vertical load of 318 pounds (144.2 kilograms) on the tower. This vertical load is more than the weight of the antenna! It should also be emphasized that these loads are in addition to the vertical loads caused by the initial tension in the guy wires.

The vertical load can be reduced by making the guy wires longer; i.e., moving the bottom end of the guy wire farther out from the base of the tower. As the guy wire approaches the horizontal, the vertical component approaches zero and guy-wire tension approaches the total wind load at the top of the tower — 238.5 pounds (108.2 kilograms).

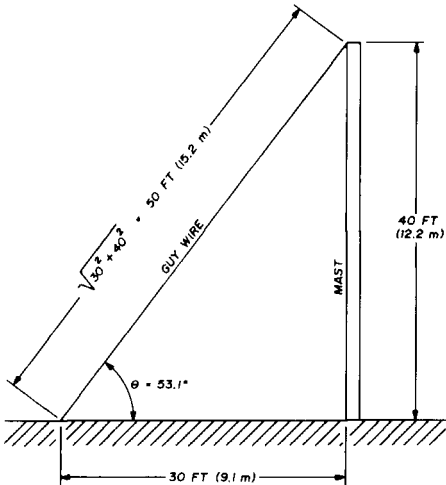

fig. 7. Guy wire arrangement. Length of guy is easily calculated by use of the Pythagorean theorem.

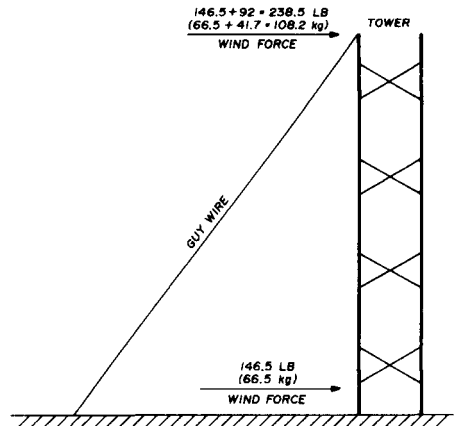

fig. 8. Horizontal forces of tower and antenna on a guyed tower.

So far we have considered the involvement of just one guy wire. When considering two guy wires you might think that for the same horizontal wind load, the tension in each guy wire would be one-half the tension for one wire. Unfortunately, it does not work out that easily. Let's consider a tower held by three guy wires at 120° intervals, as shown in fig.10. This is a typical arrangement. If the wind blows in the direction of arrow A, guy wire number-1 takes the wind load and the situation is as explained for one guy wire. If the wind blows as shown by arrow B, things are slightly different, as shown by the vector diagram in fig. 11. Using the same numbers as in the example above, the horizontal wind load of 238.5 pounds (108.2 kilograms) is shared equally by guy wires 1 and 2, so we allow 119.3 pounds (54.1 kilograms) on each. In this case the third guy wire carries none of the load. The horizontal force in the direction of each guy wire is thus

$$F_H = \frac{119.3}{\cos 60^\circ} = 238.5 \text{ pounds}$$

$$F_H = \frac{54.1}{\cos 60^\circ} = 108.2 \text{ kilograms}$$

As in the preceding example, the tension on each guy wire is 397.2 pounds (180.2 kilograms) and the vertical com-

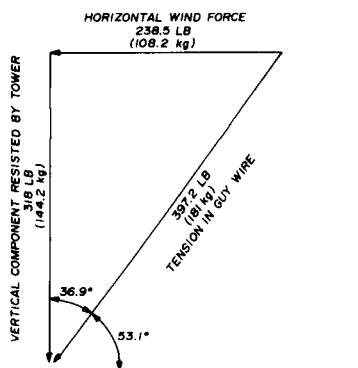

fig. 9. Vector diagram of guy wire tension. Note that the vectors represent reactions in the guy wire and not the forces acting on the guy.

ponent for each guy wire is 318 pounds (144.2 kilograms) – a total of 715.2 pounds (324.4 kilograms). The total is thus twice the vertical load generated by a wind blowing in the same direction as any one guy wire. It is easy to see that wind loads can add up pretty quickly!

The use of guy wires imposes a penalty in that the tower and foundation must be designed for greater vertical loads. The advantage of guy wires is that the tower and foundation need not be designed to resist an overturning moment. The tower designer's choice is between vertical loads and overturning moments. Also, it is much more expensive to build to resist the overturning moment than it is to withstand a straight vertical load.

An important factor to be considered in the installation of a guyed tower is the initial tension in the guy wires. If the guy wires are too loose, the tower will sway excessively. If the guys are pulled too tightly, an excessive vertical load may be put on the tower. In fact, in large installations it may be possible to buckle the tower with excessive initial tension. It is therefore necessary to compromise between stiffness and reasonably sized structural members in the tower.

antenna size

In an earlier example we assumed the area of the antenna was known from the

manufacturer's data. If the antenna is homemade, I suggest that you calculate its area the same as you would for the tower. Consider each element separately and apply the cylindrical correction factor. Calculate the area looking down the axis of maximum radiation and also at right angles to this axis. Choose the area that is larger.

Because of the increasing interest in 1250 MHz and above, and the easy availability of parabolic antennas with solid reflectors, it is both interesting and instructive to apply the above principles to a parabolic dish and compare these with a tower. We will assume a dish with a 10-foot (3-meter) diameter and a 100 mph (161 kph) wind. From eq. 1 the wind pressure caused by a 100-mph (161 kph) wind is 40 pounds per square foot (195.3 kilograms per square meter). The projected area is

$$\frac{\pi d^2}{4} = \frac{\pi(10)^2}{4} = 78.5 \text{ square feet}$$

$$\frac{\pi d^2}{4} = \frac{\pi(3)^2}{4} = 7.3 \text{ square meters}$$

and the total horizontal wind pressure is $(78.5 \text{ ft}^2) \times (40 \text{ lb/ft}^2) = 3140 \text{ pounds}$
 $(7.3 \text{ m}^2) \times (195.3 \text{ kg/m}^2) = 1426 \text{ kg}$

If a 10-foot (3-meter) antenna is to look at the horizon to see a rising

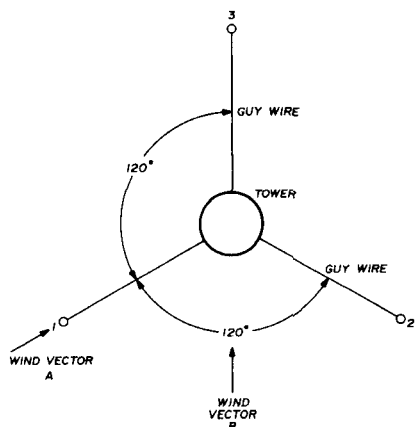

fig. 10. Tower held by three equally displaced guy wires.

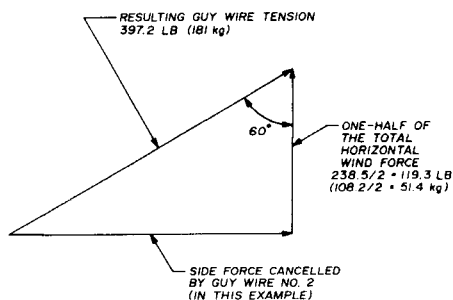

fig. 11. Vector diagram of loads in the case of two guy wires.

satellite, as shown in fig. 12, the mounting structure must be at least 6-feet (1.8-meters) tall to provide ground clearance. Thus, the minimum overturning moment will be

$$(3140 \text{ lb}) \times (6 \text{ ft}) = 18,840 \text{ pound-feet}$$

$$(1426 \text{ kg}) \times (1.8 \text{ m}) = 2566.8 \text{ kilo-gram-meters}$$

$$(25.17 \times 10^{10} \text{ dyne-cm})$$

Note that a 10-foot (3-meter) parabolic dish mounted on a 6-foot (1.8-meter) support has approximately twice the overturning moment of a 3-element, 20-meter beam mounted on a 40-foot (12.2-meter) tower.

Unfortunately, this is not the whole story. The above calculations are for a head-on wind. Experiments have shown that the greatest wind force on a parabolic antenna occurs not for a head-on condition, but when the wind is blowing at an angle to the antenna axis as shown in fig. 13.

For the antennas of one manufacturer⁴, this wind angle is 56° and the maximum force is 10-percent higher than for a zero-degree wind angle. The reason for this is that at some wind angles the rear surface of the dish acts as an air-foil which develops *lift* in a manner similar to an aircraft wing, thereby increasing the horizontal force on the antenna.

Because this extra force depends on the shape of the antenna, it may not be the same for all parabolic antennas. The antenna parameter that has the greatest effect on this additional lifting force is probably the focal length of the antenna

as this determines how deep the dish must be for a given diameter and hence will effect the lift/drag coefficient of the dish. It is not practical to give lift coefficients or angles of maximum wind loading for all cases, but a 10-percent increase in wind loading due to lift at an angle of 56° is probably a good approximation for most parabolic antennas.

The relatively large wind loading of a parabolic dish can be considerably reduced by perforating the dish. If the holes are small compared to the wavelength of operation, the effect on antenna performance will be negligible, but the wind loading will be decreased considerably.

ice loading

The preceding material has not considered the effect of ice. The magnitude of the additional load imposed by ice will depend on your location. Do you live in Miami, Florida, or Bismarck, North Dakota? The effect of ice, of course, is to increase the projected area of the structural members, thereby increasing the wind load. Unfortunately, it frequently occurs in many parts of the country that the strongest winds occur during ice

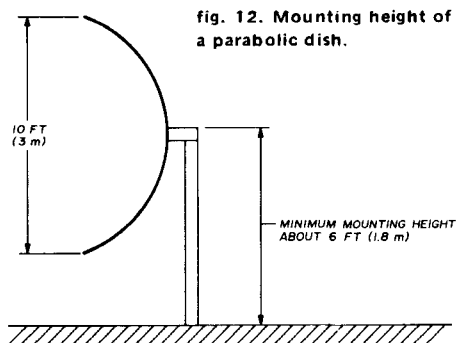

fig. 12. Mounting height of a parabolic dish.

storms, thereby compounding the problem. If you feel you should consider ice loads, I suggest you contact the chief engineer of a local broadcast station and find out what ice thickness his towers are designed to handle. Calculate the projected areas when loaded with the maximum expected thickness of ice. Remem-

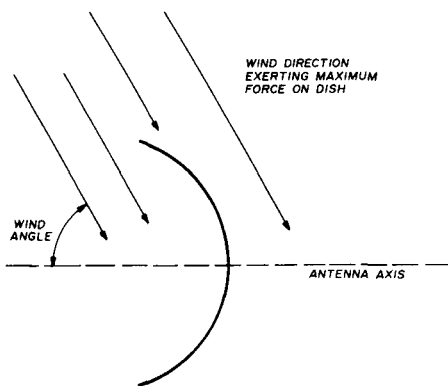

fig. 13. Relationship of parabolic antenna and direction of wind exerting maximum force.

ber, too, that ice coats both sides of the structural members so that a 1/2-inch (13 mm) radial thickness of ice will increase the overall dimensions by 1 inch (25 mm).

summary

In the above material I have shown how to calculate the overturning moments caused by wind forces on antenna structures of the type used by most amateurs. These forces can be appreciable, especially when augmented by ice. Parabolic antennas have even higher wind loadings. I have also discussed the use of guy wires, and have shown how these eliminate the overturning moment but increase the vertical loads on the tower.

The procedure for calculating the wind loading on a conventional tower/antenna combination may be summarized as follows:

1. Calculate the projected area of the tower.
2. Apply the appropriate correction factor for cylindrical surfaces and/or triangular or square cross section, as necessary.
3. Determine the maximum expected wind velocity.
4. Calculate the horizontal force on the tower.
5. Determine the effective area and horizontal force on the antenna.

6. If the tower is guyed, calculate the tension in the guy wires due to wind loading and determine the additional vertical loading of the tower.

7. If the tower is free standing, determine the moments on both the tower and antenna separately, and add.

The wind loading on a parabolic dish is calculated in the same manner as on any other structure, but maximum wind loading will occur at an angle to the main antenna beam and the numbers will be surprisingly high. Towers, like people, can carry only a limited load before they start to sway. A good man knows his own limit; a good amateur knows his tower's limit.

references

1. Electronic Industries Association (EIA) Standard RS-222-B, December, 1972, available from EIA, 2001 Eye Street, NW, Washington, D.C. 20006, price, \$4.50.
2. H.C.S. Thom, "Distribution of Extreme Winds in the United States," *Proceedings of the American Society of Civil Engineers, Journal of the Structural Division*, April, 1960, page 11.
3. H.C.S. Thom, "New Distribution of Extreme Winds in the United States," *Proceedings of the American Society of Civil Engineers, Journal of the Structural Division*, July, 1968, page 1787.
4. *Bulletin 1015B*, The Andrew Corporation, 10500 West 153rd Street, Orland Park, Illinois 60462.

ham radio

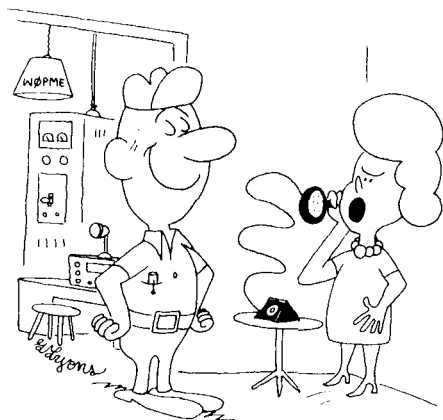

"Right now he's out of this world . . . He just bounced a signal off of the moon!"

scanning receivers

for two-meter fm

A discussion of
vhf scanner-monitors,
how they work,
and how they
may be used
on vhf fm

For many years vhf fm monitor receivers have enjoyed a modest but reasonably steady popularity with a variety of police officers, firemen and assorted buffs, both amateur and professional. Those early models suffered from most of the same ills which blessed contemporary amateur vhf equipment: instability, difficult tuning and so forth.

The introduction of crystal-controlled, solid-state models increased the popularity of the monitor receiver within the original market but still did not cause a widespread interest among amateur radio operators. In those days, you will recall,

two-meter activity was mostly a-m, scattered over a relatively large portion of the band, with no definite channelization outside of a few local net frequencies.

Newer monitor receivers couple crystal control with the ability to search through many channels for activity by using digital logic techniques for scanning. The scanner receiver sequentially looks at four, six, eight or even ten channels prechosen by the user. Amateur use of monitor receivers has increased due to both the availability of reasonably priced models and the channelization of our own two-meter fm activity.

simple scanner

Dual-receive Citizens Band equipment is neither vhf-fm nor amateur but is sufficiently simple and representative enough to warrant our consideration—if only for instructional purposes!

CB scanners were developed so that a single unit could be used to simultaneously monitor a regular working channel and the national emergency channel. The

fig. 1. Block diagram of a typical dual receive CB scanner receiver. A J-K flip-flop alternately grounds the 23-channel synthesizer crystal bank, then the Channel-9 crystal, permitting simultaneous monitor capability.

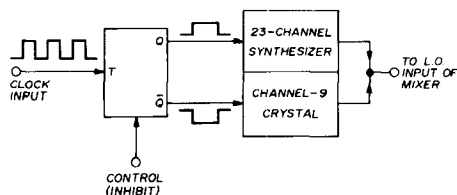

Joseph J. Carr, K4IPV, 225 North Glebe Road, No. 3, Arlington, Virginia 22203

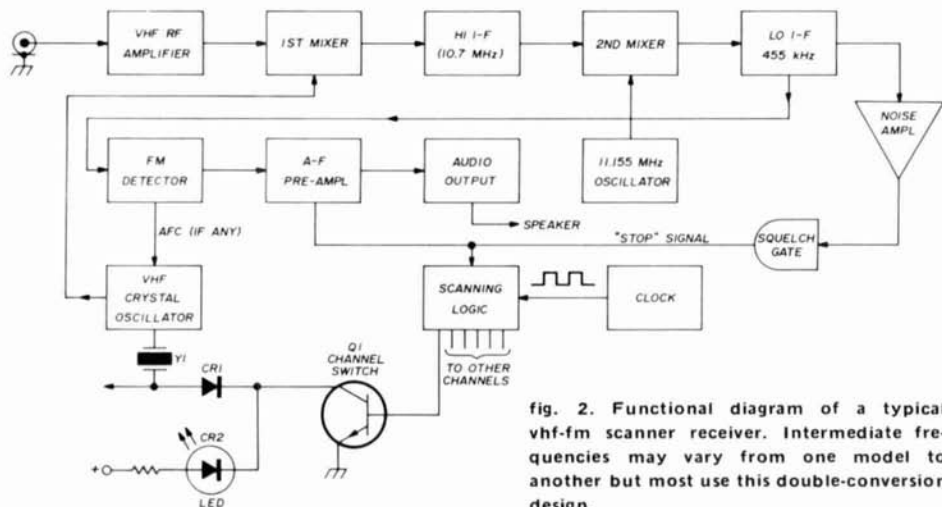

fig. 2. Functional diagram of a typical vhf-fm scanner receiver. Intermediate frequencies may vary from one model to another but most use this double-conversion design.

scanner logic switches the receiver back and forth between the channel selected by the multi-crystal synthesizer and channel 9. An increase in the agc voltage, indicating that a station is in the pass-band, causes the scanner to stop seeking and latch onto the signal. Basic operation

Scan Monitor manufactured by Pace is typical of scanners used by amateurs for two-meter fm. (Photo courtesy Pace).

of the circuit is shown in fig. 1. A J-K flip-flop selects which local oscillator is in control of the receiver at any instant of time. An *inhibit* signal causes the circuit to latch when the agc voltage is above a certain level.

vhf scanners

A typical vhf fm scanner is usually a double-conversion receiver such as that shown in fig. 2. A local oscillator, operating from crystals selected by the scan logic, is connected to a mixer where it beats against the incoming rf signal to produce a high i-f in the 10- to 13-MHz range, with 10.7 MHz being most popular. A second mixer heterodynes the output of another crystal oscillator (11.155 MHz in this case) to produce a low i-f (usually 455 kHz). This signal is then handled by the receiver i-f and detector stages in the usual manner.

The squelch circuit of the monitor receiver does more than just keep the output quiet in the absence of a signal: it provides the *stop* command signal to the scanner. Without this ability scanning would be little worse than a useless nuisance.

scanning logic circuits

Fig. 3 shows the partial schematic of a scanning circuit. A unijunction transistor,

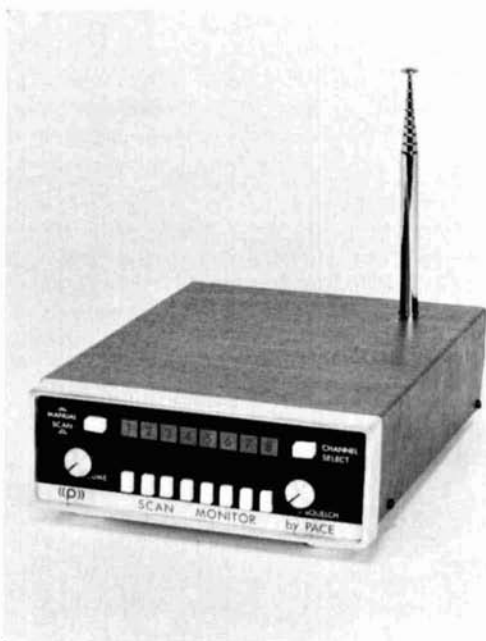

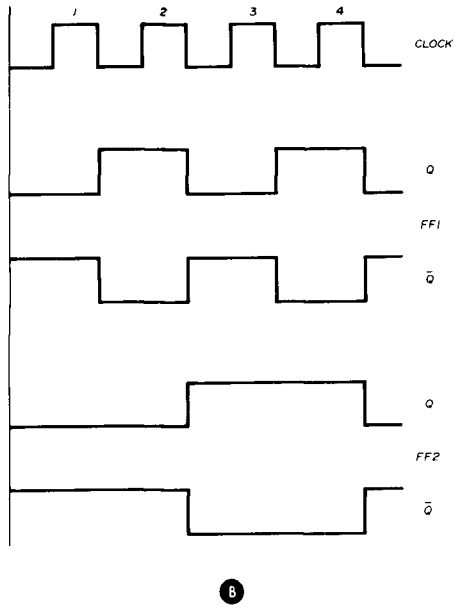
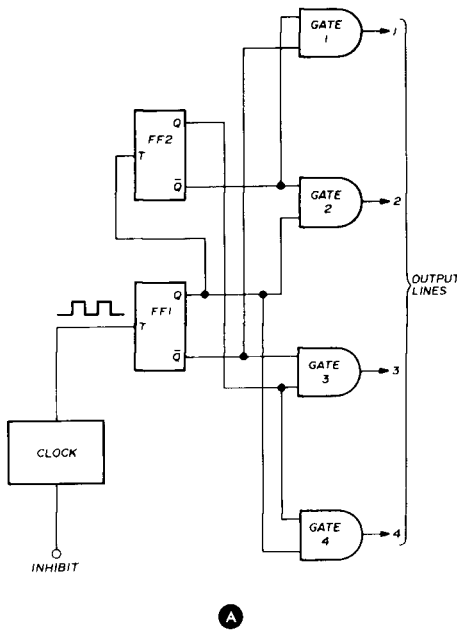

fig. 4. Logic diagram of a four-channel decoder using one dual J-K flip-flop IC and one quad two-gate (A). Waveform diagram showing design rationale for the four channel scanner is shown in (B).

Q1, operates as a pulse-generator clock. This circuit supplies sawtooth pulses to the pulse-shaping and control circuit. In that section the pulses are changed so that the counter circuits to follow see the abruptly changing waveforms they like.

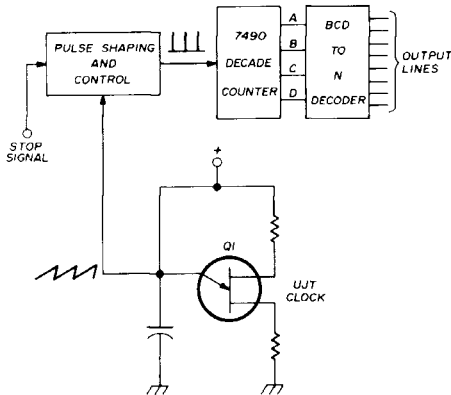

fig. 3. Partial schematic of the scanning logic of a typical receiver. In this design the BCD lines from the counter are decoded into N distinct output lines where N is the number of channels. The easy availability of IC octal and decimal decoders make eight- and ten-channel designs especially appealing.

The control portion of the circuit interrupts, on command, the flow of pulses to the SN7490 decade counter.

The Binary Coded Decimal (BCD) output from the counter is fed to a decoder which selects one of several output lines each time an input pulse is received. Examples can be found where the decoder is a suitable connection of NOR/NAND gates or an octal or decimal decoder IC such as found in decimal counting units.

The simple four-channel scanner in fig. 4A uses two J-K flip-flops (which are usually housed on the same IC chip) and four two-input gates (also usually a single IC). This circuit sequentially selects from among a bank of four crystals.

Waveforms which explain the operation of this circuit are shown in fig. 4B. The NAND gates are wired to the flip-flops in such a way that they produce a grounded output (logic zero) only when *both* inputs are high (logic 1). Notice the waveforms from FF1 and FF2 underneath clock pulse number 1. At this time only the \bar{Q} of FF1 and the \bar{Q} of FF2 are

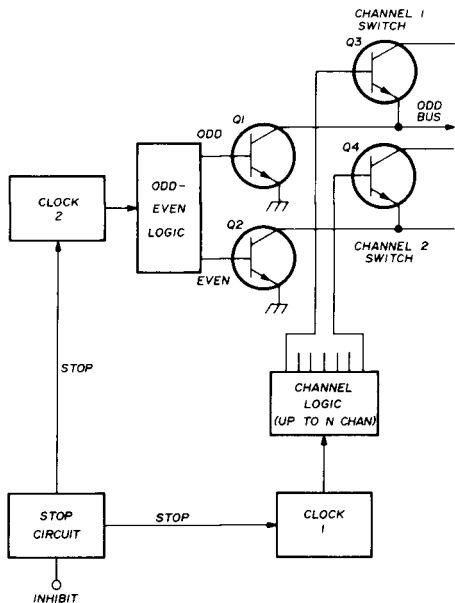

fig. 5. A simple four-channel scanner can be made to scan twice as many channels with only the added complexity of an odd-even selector. In this case the normal scan logic is the same for both channels—which is selected during any given iteration of the logic signal is determined by the odd-even flip-flop.

high so they are used to drive gate 1. When clock pulse 2 arrives the Q output of FF1 and the \bar{Q} of FF2 are high while all others are low. They are used to drive gate 2. This sequence continues through all four pulses from the clock, then repeats.

Most scanner receivers offer more than four channels. In fact, the standard seems to be eight. Since the binary system is based on powers of two it might be imagined that a mere doubling of the circuit of fig. 4 would suffice. In actuality, however, the gating of eight channels is a bit more complex.

A few receivers simultaneously scan two four-channel crystal banks which are designated *odd* and *even*. One additional flip-flop sequentially selects from these two alternate banks. An example of the odd-even select system is shown in fig. 5.

crystal switching

Transistor Q1 in fig. 6 is the regular

vhf overtone crystal oscillator used to drive the first mixer. Although the circuitry for only one channel is shown here, assume that each channel will have a similar arrangement. The cold end of the crystal, Y1, is grounded through transistor Q2 when Q2 is turned on by command from the logic circuit.

When the logic circuit selects the channel a positive voltage is applied to the base of the appropriate switching transistor. This saturates the transistor, causing a collector-emitter resistance of only a few ohms. Under this condition diode CR1 is forward biased (allowing the crystal to be grounded) and the light-emitting diode, CR2, finds a current path to ground. Depending upon design you will sometimes find lock-in or lock-out switches which will either manually select a channel or prevent it from being energized. Most scanners incorporate a small trimmer capacitor to net the crystal on their respective channels.

crystal selection

As some of us have discovered the hard way, crystals are neither absolutely calibrated (despite case markings) nor do they necessarily remain on frequency once in a circuit. The exact frequency of operation depends upon both the ambient temperature and the circuit parameters. It is, therefore, necessary to state precisely your requirements when ordering from a crystal or scanner manufac-

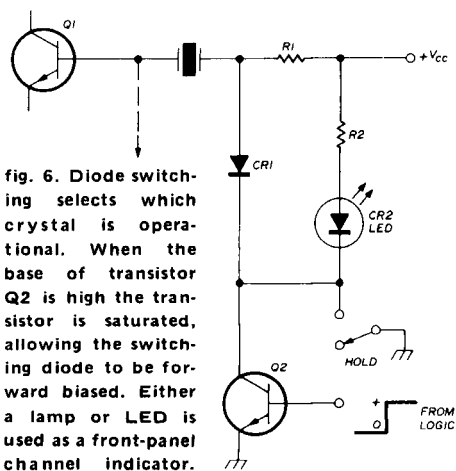

fig. 6. Diode switching selects which crystal is operational. When the base of transistor Q2 is high the transistor is saturated, allowing the switching diode to be forward biased. Either a lamp or LED is used as a front-panel channel indicator.

turer. It isn't like the old days of 40-meter CW where you bought a crystal ± 2 kHz.

Crystals for any given scanner can usually be purchased from the respective dealers or from a crystal manufacturer. Before you order, especially from a crystal manufacturer, you will need certain facts about the required crystal. One piece of data, of course, is the operating frequency. To find this you must know both the channel frequency and the i-f of your unit. You also need to know whether crystal operation is in a fundamental or one of several overtone modes.

Vhf-fm scanners typically (but not universally) operate in the fundamental mode on low band (30-50 MHz), the third overtone on high band (148-174 MHz) and the ninth overtone on uhf. Assuming this to be true in your own receiver, use one of the following formulas for determining crystal frequency:

Low band (including 6 meters):

Crystal frequency = Channel frequency + i-f

High band (including 2 meters):

Crystal frequency = $\frac{\text{Channel frequency} + \text{i-f}}{3}$

uhf:

Crystal frequency = $\frac{\text{Channel frequency} + \text{i-f}}{9}$

Note that in some receivers the manu-

*Scanner-Monitor Servicing Data, Volume 1, SD-1, 1972, and Volume 2, SD-2, 1973, Howard W. Sams and Co., Inc., \$4.95 each from Ham Radio Books, Greenville, New Hampshire 03048. Volume 1 covers the **B&K** PF-1; **Browning** XM-888; **Johnson** Duo-Scan Low Range, High Range, 241-0340-001, and 241-0340-002; **Midland** 13-915 and 13-925H/L/M; **Pace** Scan 108H/L/U, 280 and 308; **Pearce-Simpson** Gladding Hi-Skan; **Penneys** 981-6065, 981-6066 and 981-6067; **Realistic** Patrolman Pro-7 (20-5001), Patrolman Pro-8 (20-162) and Patrolman Pro-9 (20-164); **Sonar** FR-104, FR-105, FR-2516, FR-2517, FR-2525, FR-2526 and FR-2528; and **Teaberry** Scan "T". Volume 2 covers **Electra** Bearcat III; **Midland** 13-922 and 13-927; **Regency** R1HT1-1, R1LT1-1, R1UT1-1, R2HT1-1, R2LT1-1, R2-

factorer will specify that you are to *subtract* the i-f from the channel frequency.

Prepare a simple chart for the crystal supplier listing the following:

1. Make and model of receiver.
2. Crystal frequency desired.
3. Holder style (consult catalog).
4. Mode of operation (fundamental, third overtone, etc.).
5. Circuit capacitance.
6. Drive level in milliwatts.
7. Maximum allowable series resistance.
8. Temperature (if in oven).

This information can usually be found in the service manual for your receiver. If a manual is not available consult Howard Sams' *Scanner-Monitor Service Data*.* This handbook covers most of the more popular types of scanner receivers.

It is worth noting that the cost of crystals can almost double the cost of the scanner if you don't shop around a little. It is often advisable to buy a unit custom set-up from the factory with all crystals in place. This is generally less expensive and is also more likely to result in satisfactory performance should your local dealer be unable to provide good quality alignment service.

other scanner-receiver circuitry

For the most part the remaining

UT1-1, TME-16U, TMR-1U and TMR-8U; **Tennlec** Tennetrac I/II/IV; and **Unimetrics** Digi-Scan 4+4 and Digi-Scan-8.

Also available is *Scanner-Monitor Data*, Volume III, SD-3, 1974, \$5.95 from Ham Radio Books. This volume includes schematics, parts lists and service adjustments for the following scanner receivers: **Electra** Jolly Roger; **Johnson** Hi/Lo Duo-Scan, UHF/VHF Duo-Scan (late production), UHF Mono-Scan and VHF Mono-Scan; **Midland** 13-914; **Pearce-Simpson** Cherokee 8+8, Cheyenne 8 (PR-78) and Comanche 16 (PR-160); **Regency** MT-15S, TME-16H/L, TME-16H/LH/U, TME-16H/LL/U, TME-16H/LM/U, TMR-1H, TMR-1L, TMR-4H, TMR-4L, TMR-8H, TMR-8L, TMR-8H/LH, TMR-8H/LL and TMR-8H/LM.

circuits found in scanner receivers will closely parallel similar circuitry in other vhf-fm receivers including quite a few two-meter fm transceivers.

The second mixer of one popular scanner receiver is shown in **fig. 7**. Input signals to the mixer are coupled through a tank circuit and a ceramic crystal band-pass filter. The output of the mixer is tuned to the lower i-f by another, similar crystal filter.

Since most commercial transmitters use narrowband fm (± 5 -kHz deviation) a 12- to 16-kHz passband is required. This allows the use of many low-cost ceramic filters such as the Murata line from Japan. These same filters in different bandwidths are used in many home and auto fm and fm-stereo broadcast radios.

I-f amplification is almost universally supplied by a one- or two-stage IC amplifier. The detector might be an ordinary diode type or it might be an IC. Some scanners use the standard ratio detector/discriminator circuits which feature i-f amplification, limiting and detector diodes in one IC package. An example is the RCA CA3043. Others use an IC quadrature detector such as the Motorola MC1357.

An unusual squelch circuit is shown in **fig. 8**. This design uses switching diodes to generate squelch action. This circuit produces little audio distortion because low-level ac (i.e., audio) signals can ride on top of high levels of dc which forward biases the diode. The circuit operates by

causing the transistor to saturate. When that occurs the B+ to the diodes is shunted to ground, causing the diodes to be reverse biased. This cuts off the audio path. When the transistor is inoperative

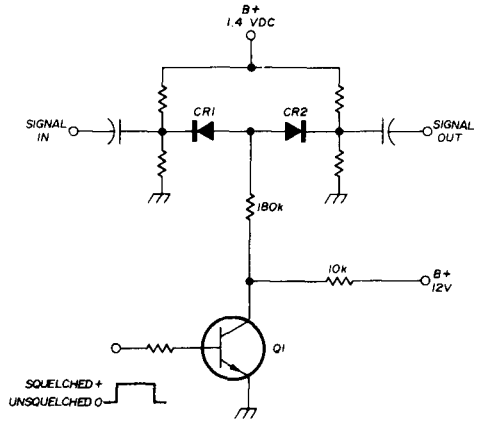

fig. 8. Diode switching is also useful in squelch circuits. When transistor Q1 is cut off B+ flows through the 10k and 180k resistors, forward biasing the switching diodes, allowing low-level audio signals to pass through. When the transistor is saturated, however, the B+ to the diodes is shunted to ground and they are effectively reverse biased.

again the B+ biases the diodes to pass audio signals.

future of scanners

The scanner market will undoubtedly be soon overrun with lower cost import and domestic models. Many of these receivers will require modification, even to the extent of completely changing the front-end tank circuits to a new range, before they can be used on the amateur bands. Others either already have sufficient range or will be available in amateur band models. In either event expect to see more amateur use of these receivers. They allow you to monitor several active frequencies or repeaters at one time. Perhaps the next logical extension of this concept is to make a transmitter in the same box which also scans. The combination could then be set to keep tabs on *all* local activity.

ham radio

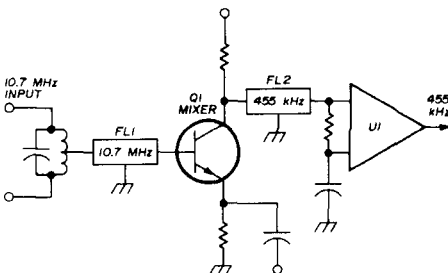

fig. 7. Most modern vhf-fm scanner receivers use modern design for the i-f strip and second mixer. This circuit uses ceramic bandpass crystal filters and an IC amplifier, U1.

integrated-circuit ssb transceiver

Complete
construction details
for a miniature
ssb transmitter
and receiver
using Plessey ICs

This article describes the i-f and audio circuitry of a single-sideband transceiver designed by the Applications Department of Plessey Semiconductors using their SL600-series integrated circuits. The transceiver may be used at any frequency from a few kHz to 500 MHz.

The unit described in this article consists of a single printed-circuit board which requires only the addition of a local oscillator, a preselector, a linear amplifier, volume control, microphone and loudspeaker to build a complete transceiver.

receiver

The receiver is a single-conversion superhet with a 9-MHz i-f. To optimize its intermodulation performance the incoming signal is fed directly to a hot-carrier diode ring mixer and then to the crystal

filter; there is no rf amplifier. The i-f sensitivity is such that at frequencies of 30 MHz or less no rf amplification is required if a reasonable antenna is used (as it would be with a transceiver). However, if the receiver is used at frequencies above 30 MHz, or with a less than ideal antenna, some rf gain may be necessary to obtain the necessary noise figure. The rf amplifier should have the lowest gain consistent with the frequency and antenna to be used and must have good large-signal handling capability if receiver performance is not to be degraded.

The mixer is an Anzac MD108 hot-carrier diode double-balanced modulator.* This device was chosen for its conveniently small size, high performance and low cost, but similar devices from other manufacturers could also be used. All the ports of this modulator are designed for 50 ohms; two have a frequency range of 5 to 500 MHz while the third covers the frequency range from dc to 500 MHz. The input from the antenna is applied to the dc- to 500-MHz port via a preselector, and the local oscillator—at a level of +7 dBm (500 mV rms)—is applied at pin 8 (see fig. 1). The mixer output from the rf port passes through a toroidal transformer to match it to the 500-ohm input impedance of the crystal filter. If other types of filters are used it may be necessary to re-design the impedance-matching transformer.

Once the signal has passed through the

*Anzac MD-108 double-balanced mixers are available in small quantities from Anzac Electronics, 39 Green Street, Waltham, Massachusetts 02154. The price is \$7.00 each, plus postage.

Brian D. Comer, G3ZVC, Senior Applications Engineer, Plessey Semiconductors

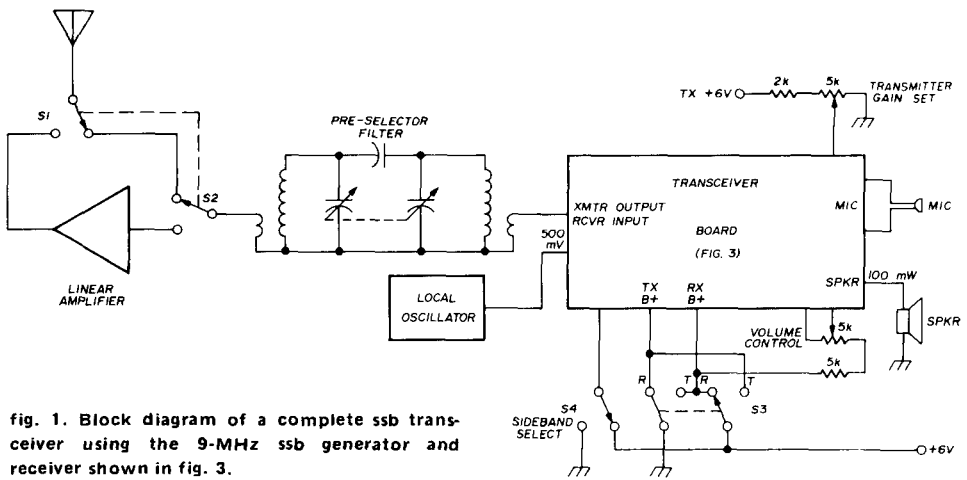

fig. 1. Block diagram of a complete ssb transceiver using the 9-MHz ssb generator and receiver shown in fig. 3.

crystal filter, a 2.4-kHz bandwidth 9-MHz filter with 90-dB stopband suppression, there is little further risk of cross-modulation or intermodulation. The i-f strip consists of three cascaded Plessey SL612C* i-f amplifiers followed by an SL640C product detector. Without agc applied each SL612C has 34-dB gain and 15 MHz bandwidth. Since a broadband i-f strip consisting of three SL612Cs has more than 100-dB gain and 15 MHz bandwidth, it can very easily become unstable. Therefore, the circuit board layout is very important (see fig. 4). It is relatively easy to build a three-stage, broadband i-f strip on double-sided printed-circuit board if the component side has a plane of grounded copper, but on single-sided board the layout shown in fig. 4 should be rigidly adhered to.

The beat-frequency oscillator for the product detector uses an fet circuit that delivers about 100 mV rms to the SL640C product detector. This oscillator also supplies the carrier for the transmitter balanced modulator. One of two crystals, for upper or lower sideband, is selected by a diode switching arrangement.

The detected audio from the product detector drives an SL630C audio output stage which is capable of providing about

65 mW to headphones or a small loud-speaker. The detected audio also drives an SL621C agc system. Since the SL630C has voltage-controlled gain, the volume control consists of a potentiometer which provides a control voltage to the SL630C. If 65 mW is insufficient output (it is worth listening to it before deciding as it is usually adequate for domestic listening) an external, higher power audio amplifier may be driven either from the SL630C output or directly from the product detector.

The agc is provided by an SL621C audio-derived agc system. Its output is buffered by a transistor Q2 so an S-meter may be connected if desired. Since Q2 reduces the available agc voltage swing,

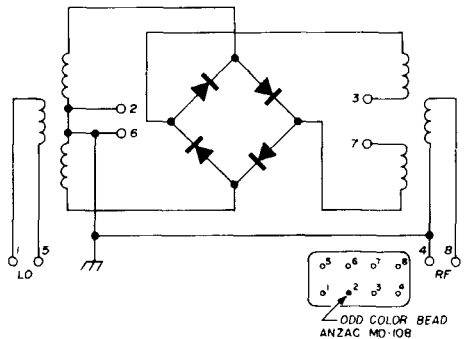
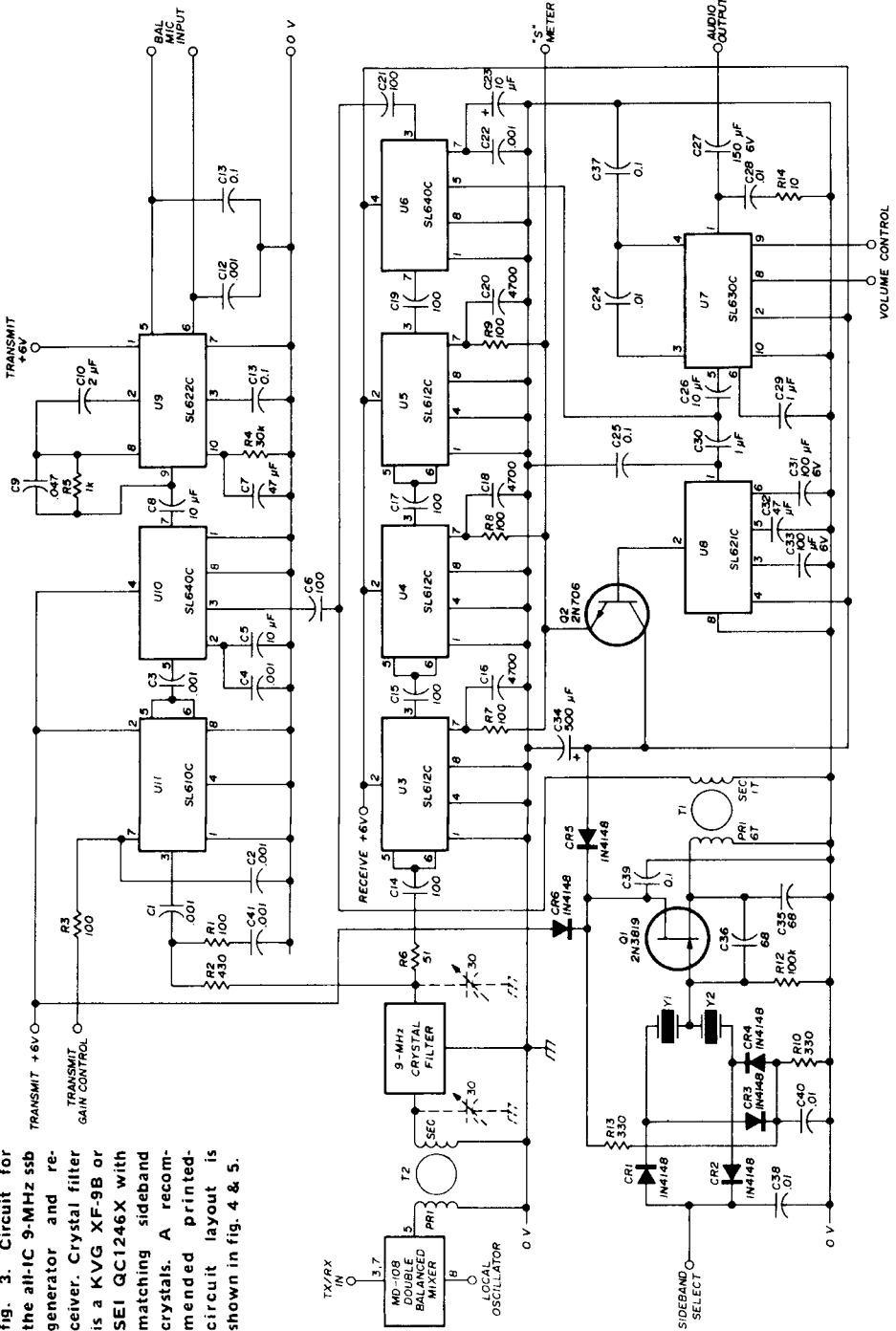

fig. 2. Schematic diagram of the Anzac MD-108 double-balanced diode mixer. Local-oscillator signal is applied to pins 1 and 5, input (output) preselector circuit is connected to pins 3 and 7, and transformer T2 is connected to pin 8.

*Plessey integrated circuits are available from Plessey Semiconductors, 1674 McGaw Avenue, Santa Ana, California 92705.

fig. 3. Circuit for the all-IC 9-MHz ssb generator and receiver. Crystal filter and re-ceiver. Crystal filter is a KVG XF-9B or SEI QC1246X with matching sideband crystals. A recommended printed circuit layout is shown in fig. 4 & 5.



agc is applied to all three i-f stages to ensure that the agc can cope with the receiver's 112-dB dynamic range. If resistor R7 is replaced by a germanium diode there will be a delay to the first-stage agc—this may improve receiver noise figure very slightly on small signals—and is barely worthwhile. Capacitors C16, C18 and C20 are kept down

transmitter/receiver side of the crystal filter on the change-over from receive to transmit. All the transmit/receive switching on the board is achieved by turning on the appropriate power line (transmit or receive) and grounding the unused line. The grounding of the unused line is very important as instability can result if it is not done.

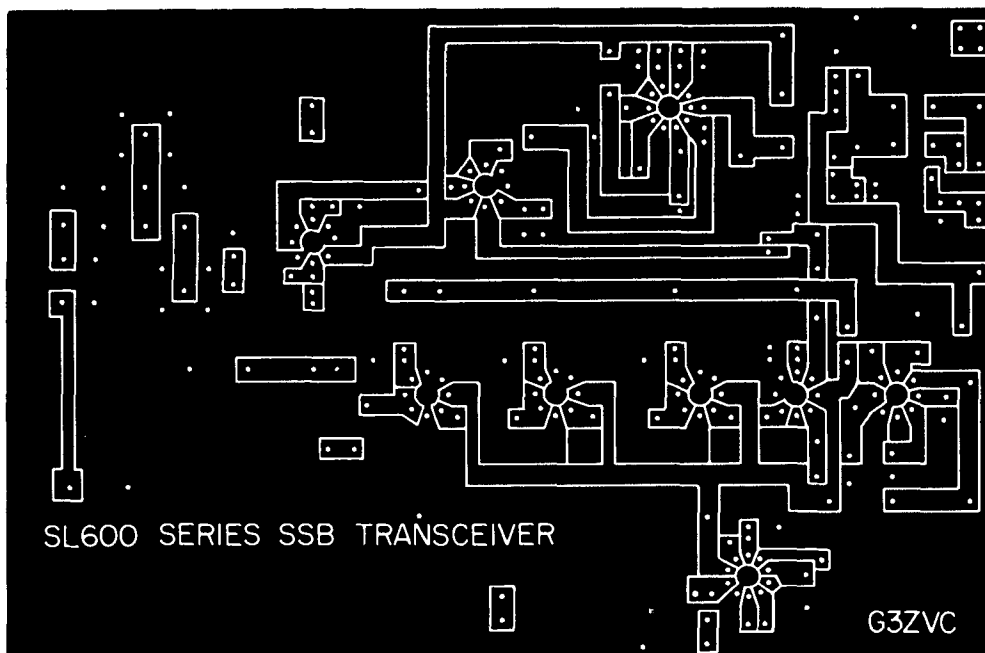

fig. 4. Full-size printed circuit layout for the 9-MHz ssb transmitter and receiver. Component layout is shown in fig. 5.

to 4700 pF to retain the ignition suppression characteristics of the system.

transmitter

The transmitter is also a single-conversion design. It generates a 9-MHz single-sideband signal using the same crystal filter as the receiver. The 9-MHz ssb is converted to the final operating frequency by the MD108 ring mixer; the unwanted frequency product is removed by the preselector. This system requires no signal switching between the antenna side of the preselector and the

The audio input from the microphone is amplified by an SL622C agc amplifier which will give a constant 100-mV rms output for a 60-dB input range. If a single-ended input is used rather than a balanced input, dynamic range is reduced to about 46 dB. In most systems 60 dB input dynamic range is too large, 40 dB being sufficient, so resistor R5 has been included in the circuit. If 60 dB dynamic range is required resistor R5 should be omitted and C9 reduced to 4700 pF.

The audio output from the SL622C

microphone amplifier goes to the SL640C double-balanced modulator. The carrier input to the balanced modulator is fed by the bfo (which works on both transmit and receive since its power may be derived from either line through diodes CR5 and CR6). The output from the

impedance-matching transformer and is mixed with the local oscillator signal to provide the final transmitter frequency (and an image which is removed by the pre-selector). This is amplified by the linear amplifier and transmitted. The output from the preselector is about 70 mV rms.

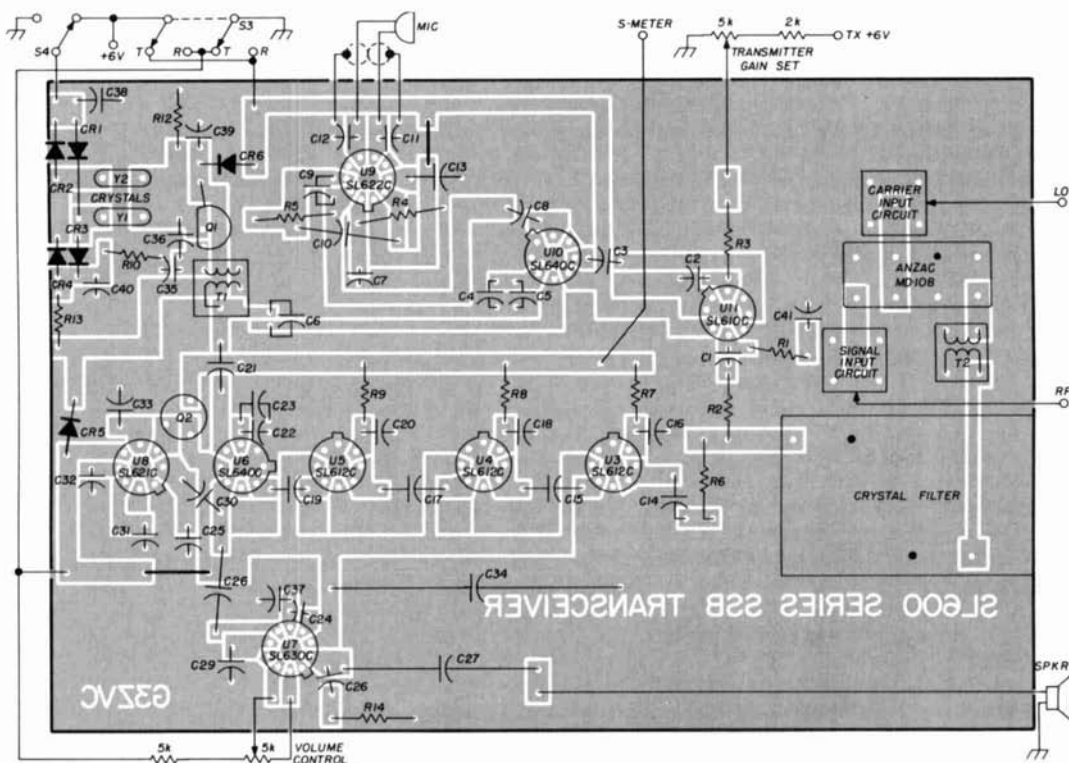

fig. 5. Component layout for the 9-MHz ssb transmitter and receiver. Space is provided for installing the input circuits for the local oscillator and signal. Design of these circuits depends upon the frequencies selected for your own application.

SL640C is a double-sideband signal with low carrier feedthrough (usually -40 dB) which is amplified by an SL610C. The gain of this particular device may be controlled either by an alc signal, derived from the transmitter linear amplifier or manually with a dc gain control. The amplified dsb signal is sent through the crystal filter to remove one sideband. Resistors R1 and R2 ensure a correct match to the crystal filter both on transmit and receive.*

The ssb output from the filter passes to the doubly-balanced diode mixer via the

construction

The complete system is built on a single-sided printed-circuit board that requires two jumpers—one in the receive supply, the other in the transmit supply. If only a receiver is required, components

*A 30-pF (nominal) capacitor from the input pin to ground will improve the passband ripple and a 20-pF capacitor from the output pin to ground will do the same. In practice, however, it has been found that these components make little difference (1-dB additional passband ripple). The KVG XF9B is the same as the SE1 QC1246AX.

R1 to R5 inclusive, C1 to C13 inclusive, C10, and the semiconductors U9, U10, U11, CR5 and CR6 must be omitted, a wire jumper connected where CR5 was, and a 500-ohm resistor connected from the filter end of R6 to ground.

The layout of the board is quite critical and changes of printed-circuit design will almost certainly lead to instability unless double-sided board is used. The design shown may be built on double-sided board quite safely.

The components used in the original unit are given in the schematic. Bead tantalum capacitors are used where possible for their small size but since they are sometimes hard to find in high capacitances at high voltages, aluminum electrolytics have been specified in three places. The WeeCon capacitors specified may be replaced with other miniature high-K ceramic capacitors but the values of components should not be changed. The resistors are all 1/8-watt, 10% types.

Transformer T2 is made on a ITT CR-071-8A toroid core (the Amidon T-37-2 is a suitable substitute). Four 2-inch (5-cm) lengths of number-26 wire are twisted together and two turns are wound on the core with the twisted wire. The ends are then opened and three windings are connected in series for the filter winding and the fourth is used as the winding connected to the diode ring. Transformer T1 is wound on a core of the same type and has a 6-turn primary and a single turn secondary.

This ssb transceiver is probably the simplest which may be made using the Plessey SL600 series ICs, but its performance is not compromised in any way. It has a sensitivity of better than $0.5\mu\text{V}$ for 10-dB signal-to-noise ratio, it can handle signals of over 200 mV rms at the diode mixer with minimal intermodulation distortion, and the board uses less than 500 mW on transmit or receive. It has been designed so that anyone with basic technical competence but without previous experience in ssb transceiver design can build a successful ssb transceiver.

ham radio

NEW RINGO RANGER

for Amateur FM

Get extended range with this exciting new antenna. A one eighth wave phasing stub and three half waves in phase combine to concentrate your signal at the horizon where it can do you the most good.

6 dB Gain over $\frac{1}{4}$ wave whip

4.5 dB Gain over $\frac{1}{2}$ wave dipole

ARX-2 146-148 MHz
\$24.50

ARX-450 435-450 MHz
\$24.50

ARX-220 220-225 MHz
\$24.50

Extend your present AR-2 Ringo with this RANGER KIT. Simple installation.

ARX-2K \$9.95

IN STOCK AT
YOUR LOCAL DISTRIBUTOR

Cush
Craft
CORPORATION

621 HAYWARD STREET
MANCHESTER, N. H. 03103

harmonic phase detector

Circuit description
of a simple harmonic
phase detector
that requires
input signals
to have a 2:1
frequency relationship

The phase lock loop has found many applications in modern electronics. One of the more important, to radio amateurs, is in the detection of fm signals where a voltage-controlled oscillator or vco is maintained at zero beat with the incoming fm signal. The control voltage generated for this application by a phase detector becomes the audio-frequency output signal. Suitable integrated circuits for this purpose are becoming available, and offer much convenience to the builder.

However, a problem in design and layout may appear wherein the vco signal may leak into a high-gain i-f system, possibly even causing saturation. An answer to this situation is the harmonic phase detector shown in **fig. 1**. This phase detector requires that the local vco operate at twice the intermediate frequency of the receiver. As a matter of fact, it won't even work if the two input signals are the same frequency! The circuit can be seen to represent a pair of peak-reading diode detectors of opposing polarity, with differential output.

The action of this circuit is illustrated in **figs. 2** and **3**. In **fig. 2**, where both signals cross the zero axis simultaneously, the positive and negative peaks of the

Henry S. Keen, W5TRS, Fox, Arkansas 72051

difference between the two input signals will be equal. Under these conditions the differential output signal will, of course, be zero. In fig. 3, however, when a phase difference exists between the cross-over points of the two input signals, this equality no longer exists, and a differential output voltage will be produced. The magnitude and polarity of the resultant output will be a function of the degree and direction of the phase difference.

In common with the reciprocating detector¹ this circuit was also devised to receive double-sideband suppressed-carrier signals as I am especially interested in the potential advantages of portable and mobile equipment in which the entire input to the final amplifier might be in the form of audio frequency power, obtained from a transistor amplifier, operating directly from the car battery.

By referring to fig. 3 it can be seen that polarity reversal of the lower fre-

quency, representing the double-sideband signal, will merely interchange the relative positions of the two peaks of either polarity. This change can have no effect upon the polarity or amplitude of the differential output.

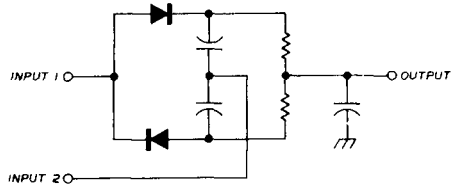

fig. 1. In this simple harmonic phase detector the two input signals must have a 2:1 frequency relationship. Applications include phase-locked loops and double-sideband signal reception.

A possibly over-simplified explanation would be to say that the 180° phase shift, inherent with the double-sideband signal, when compared with twice its frequency, is equivalent to a phase shift of 360°,

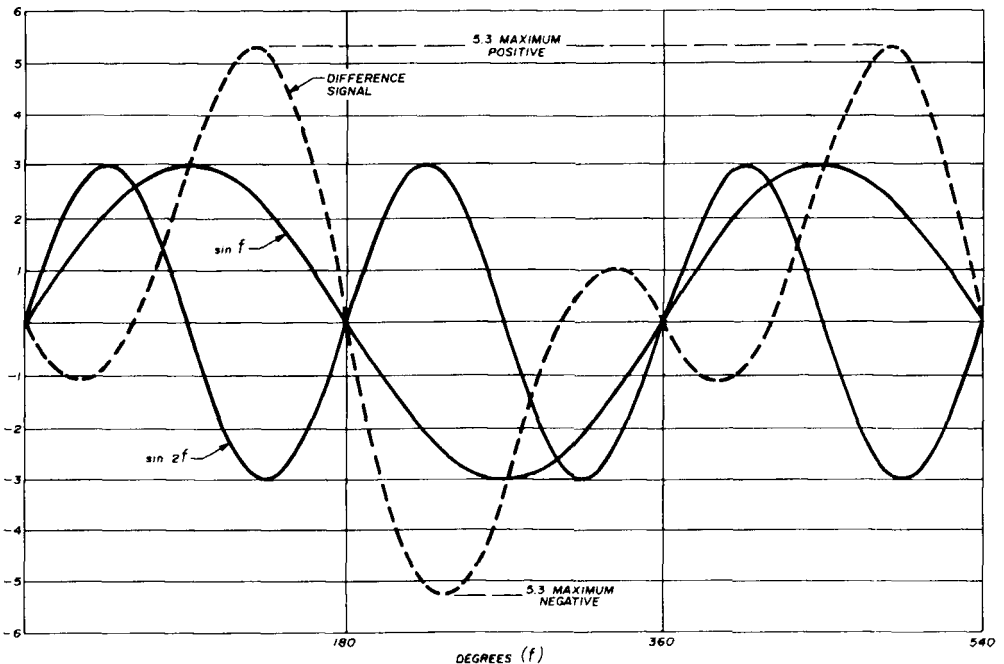

fig. 2. Operation of the harmonic phase detector with zero phase difference between equal signals at frequencies f and $2f$. Differential output is zero.

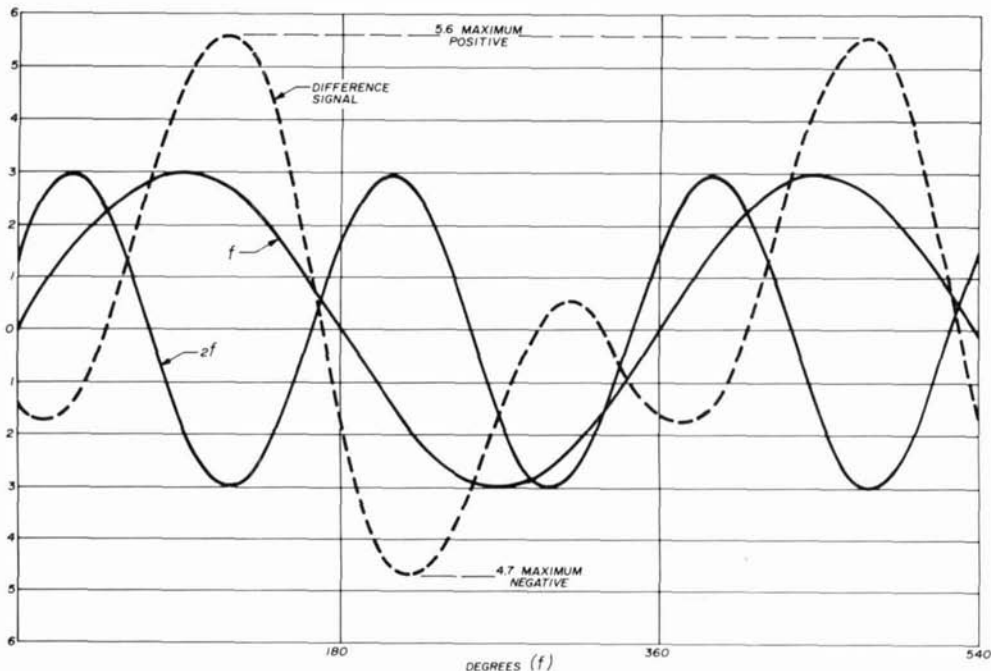

fig. 3. Operation of the harmonic phase detector showing effect of phase shift between signals at frequencies f and $2f$. Differential output voltage is produced.

which is no phase shift at all! Suitable hard limiting of the double-sideband signal before its application to the phase detector, followed by suitable integration

of the detector's output pulses permitted the necessary phase lock for double-sideband reception, but that's another story.

By grounding one of the two inputs (because the inputs are essentially in series) the detector may be made to function as an indicator of the most common form of second harmonic distortion of an audio-frequency signal, where limiting of either the positive or negative peaks is present. This fact suggests that the harmonic content of the human voice might conceivably be sufficient to lock the tuning of a ssb receiver with the aid of suitable filtering.

This simple circuit appears to have many possible applications which the amateur experimenter might find useful, and this article is prepared with that hope in mind.

reference

1. Stirling Olberg, W1SNN, "Reciprocating Detector," *ham radio*, March, 1972, page 32.

ham radio



"I wish you would learn to control your temper, and not try to punch everyone who says something you don't like."

Drake gear keeps getting better and better...

NOW, OUR FINEST... THE NEW Drake C-Line

NEW FEATURES:

- 1 kHz Dual Concentric Dial Readout
- Receiver and transmitter lock together in transceive operation
- No side controls
- Iridited cadmium-plated chassis
- Compatible with all previous Drake lines



R-4C Receiver

The receiver hams have dreamed of...



T-4XC Transmitter

The one worthy of the R-4C

NEW R-4C FEATURES:

- 8-pole crystal filter combined with passband tuning, SSB filter supplied
- Provision for 15 additional accessory 500 kHz ranges
- Transistorized audio
- Optional high-performance noise blanker
- AVC with 3 selectable time constants
- Optional 8 pole filters available for CW, AM, RTTY
- \$499.95

NEW T-4XC FEATURES:

- Plug-in relay
- More flexible VOC operation; Including separate delay controls for phone and CW
- Crystal control from front panel for amateur, Mars, commercial uses
- Provision for AFSK RTTY operation
- \$529.95

See for yourself—at your dealer's.

R. L. DRAKE COMPANY



DRAKE

540 Richard Street, Miamisburg, Ohio 45342 • Phone (513) 866-2421 • Telex 288-017

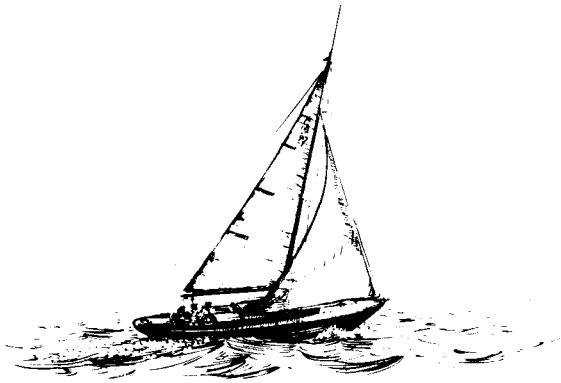

amateur marine installations

— small boat style

Overcoming the
practical problems
and legal restrictions
of hamming
from a pleasure boat

R.P. Haviland, W3MR, 136 Brownlie Road, King of Prussia, Pennsylvania 19406

Amateur radio station installations on private yachts of various sizes is increasing at a rapid rate. Operating a ham station on your boat is a nice way to combine your hobbies. However, it is also a hobby combination which has special requirements, both legal and practical. Let's discuss some of these special requirements, based on my personal experience as well as on observations of shipboard installations by other amateurs.

grounds

The radio ground system on a boat has three functions: rf grounding, lightning protection and corrosion prevention. For rf the rule is very simple—the larger the ground area, the lower the ground resistance and the greater the antenna efficiency. If it is large enough, the ground does not have to be in physical contact with the water—it can serve as one plate of a low-reactance series capacitor, with the water serving as the other plate.

The safest rule to follow for a lightning ground is to have lots of ground area in direct contact with the water, and a good direct-contact rf ground would also be a good ground for lightning. The lead wire should be large—at least number-10, and preferably larger. The radio and

lightning grounds can be kept separate, either by using a lightning arrester or by having a heavy knife switch which grounds the antenna when it is not in use. One commonly used method is to make up a lead with a heavy clip on one end and a length of bare wire or a zinc electrode on the other, fastening the clip to the antenna and dropping the electrode end over the side during storms or when the boat is not in use.

There are two factors that must be considered in anti-corrosion protection. These are corrosion due to dissimilar metals, and corrosion from stray current flow. On most boats the regular anti-corrosion measures—zinc electrodes, plus cathodic protection on metal hulls—will also take care of any stray currents resulting from the radio installation. However, a good precaution is to replace the original power switches in the radio with a type which opens both sides of the supply, completely isolating the radio from the power source when it is turned off. It is also a very good idea to inspect all underwater metal on your boat a few weeks after making any new installation or change, to detect any problem before major damage occurs.

One very successful water contact ground is made from two copper tubes, typically 3/4- to 1-inch (1.9- to 2.5-cm) in diameter and 10-feet (3-meters) long, one mounted on each side of the keel. A variation of this uses a copper sheet, 3- to 4-inches (7.6- to 10-cm) wide by 10-feet (3-meters) long, tacked to the side of the keel or to the bottom of the boat. Both are good. On sailboats, the ground connection is often made to the bolts holding the lead keel. This seems to be satisfactory, but the ground lead should be connected to a number of the keel bolts to provide the lowest contact resistance.

On fiberglass boats a good non-contact or capacitance ground can be made by attaching 10 square feet (about one square meter) or more of light copper screen or perforated mesh to the hull below the waterline, using resin as the

adhesive. This should also be satisfactory with wood boats, but I have never seen it so used. Some fiberglass sailboats carry the lead ballast inside the hull, as a casting set into the keel, and this can be used as a capacitance ground. All of these non-contact rf grounds should be supplemented by a lightning ground: I have seen an internal keel sailboat which was struck by lightning in which the charge escaped to the water by punching a number of small holes through the fiberglass at the upper edge of the keel casting.

The ground system of the sailboat on which I operate W3MR/M is a combination type. All shroud chainplates are connected by number-8 aluminum wire, a total of about 50 feet (15 meters). This makes a fairly good capacitance ground. In addition, two standard zinc teardrops on the outside of the hull are connected to this bus, further reducing the ground resistance, and giving lightning and corrosion protection. These zinc teardrops require replacement on occasion, showing that there is some current flow.

antennas

On many boats the mounting of an amateur antenna is complicated by the fact that the best antenna mounting place has been preempted by a marine radio installation. If a marine radio installation is already aboard, or one is contemplated, it should be remembered that the amateur station must be completely independent of and must not interfere with the marine installation. Compromises of the amateur antenna system, several trial installations, use of bandpass filters and the like, may be necessary.

Any of the mobile-whip or loaded-whip antennas can be used on a boat if one factor is considered. This is the extra lead length to ground, usually on the order of feet on a boat instead of inches as on an automobile. As a result, fixed-tuned loading coils will usually resonate outside the band. One solution is to use the loading coil for the next higher frequency band. Since the antenna is

actually being fed above ground, it has higher than normal impedance plus reactance. Even with adjustable loading coils, a matchbox is a good idea.

Some good mounting places for amateur-band whip antennas are: at the upper edge of the pilot house on the side away from the marine antenna; at the rail, usually on the stern quarter; at the masthead; or strapped to the mast, if it is wood. Try to keep a minimum of several feet of separation between the antenna and rigging, and as far apart as possible from other antennas.

Boats with masts can use wire antennas. On a power boat an antenna from the bow to a midships mast to the stern flagpole is good; feed can be at any convenient point, using a matchbox. On sailboats a standard installation is to insert large compression insulators at the top and bottom of the backstay, feeding it from the bottom end. Two-masted boats can have an antenna hung between the masts. My installation does this, using three separate lengths of wire cut for 10, 15 and 20 meters and operated as monopoles. The feedline coax shield is connected to the shrouds, which are grounded as noted above. In comparison tests with several other trial antennas this arrangement consistently gave the best results.

It is not really necessary to insulate rigging or wire to use it as an antenna. The objective is to get rf current flowing in a conductor that acts like an antenna. For example, on a typical medium-size sailboat the mast will be a 32- to 40-foot (about 10- to 12-meter) length of aluminum, a good approximation of a half-wave on 20 and a quarter-wave on 40. There are several ways to induce rf current flow. Some common ones are: feed the bottom end directly, if it is insulated (used on my boat on 40 and 80); use one of the shrouds as a gamma match; run a piece of insulated wire several feet (one meter) up the mast, again as a gamma match; or form the running-light leads (when present) into a coil, using this as part of a matching

network. The key to success in the use of one of these methods is a good antenna tuner (see later)— and patience in making trials.

Beam antennas are rarely seen on small boats—they are too complicated and bulky, and not worth the trouble. If you want to try using a beam there are several short-element designs on the market, and a number have been described in various handbooks. Loading coils can be used to bring a TV antenna into resonance on 6 or 10 meters, although the bandwidth will be narrow. Another possibility is an array of three or four whip antennas, say on the wheelhouse or even on the quarters.

Still another possibility is a shore antenna. For temporary use a trap vertical lashed to a dock piling is good, though it may have to be retuned as the tide changes. It is often possible to use a long-wire antenna, end fed from an antenna tuner, and run as far as possible in the general direction of preferred signals. At the ship's home port a permanent rotary beam installation may be possible.

matching

If antennas other than trap verticals are used, it is a good bet that the antenna tuner will have to handle some unusual feed impedances. This eliminates use of some of the standard designs, which are intended for a limited range of loads and relatively low reactance.

After a number of trials I settled on a homebrew antenna tuner that is a modification of an ARRL Handbook design of some years ago. One or another of its switch settings will permit matching any impedance over the range from 3 to 30 MHz; the last position grounds the antenna. The tuner described in the May, 1974, issue of *ham radio* would be a good one for this application.¹ Because of the many possibilities, adjustment of the tuner can be tedious. It seems to be a good idea to try a pi configuration first. If this does not give a satisfactory match, try the low-impedance positions for loop-fed antennas, and high-impedance

settings for other types. Several configurations and settings of your tuner may give a match; use the one which is least critical to a change in frequency.

In addition to matching, an antenna tuner also helps keep the chassis of the transmitter at rf ground. Sometimes it will still be necessary to add filtering to the mike and key leads, and to set up special grounds for the transmitter chassis.

operating convenience

Because of space limitations, it is very difficult to get an operating position on a boat which is really convenient. The best I have seen was on a fair sized sailboat, where the place called "navigator's area" on the ship's plans had been rebuilt into a radio area. Since this boat was used only in inland waters, the loss of navigational convenience could be accepted.

A suggestion—make a temporary installation, and use it long enough to find the type of operating you prefer—tied up or underway, phone or CW, net or casual, and so on. Then work out a convenient position for this type of operation. If you like net or favorite frequency operation, don't forget the possibilities of crystal control and a remote operating position.

legal matters

There seems to be considerable confusion about the proper identification when operating aboard a boat. The following are the tests I use:

If underway, operation is obviously *mobile*.

If at anchor or tied up, and the ship can get underway without interrupting a contact, operation is still *mobile*.

If some shore-side facilities are being used, and operation would have to be interrupted to get underway, operation is *portable* rather than *mobile* (typically when shore power or a shore-side antenna are used).

If the ship's location is in waters bearing

the chart notation, "Use International Rules of the Road," the designator is still *mobile* followed by the ITU Region, rather than a location and/or call area. The Americas are in Region 2. Note that operation in coastal waters of another country requires permission of that country.

For the record, here is what the FCC says about your operation from ship-board:

97.101 Mobile stations aboard ships or aircraft.

In addition to complying with all other applicable rules, an amateur mobile station operated on board a ship or aircraft must comply with all of the following special conditions: (a) The installation and operation of the amateur mobile station shall be approved by the master of the ship or captain of the aircraft; (b) The amateur mobile station shall be separate from and independent of all other radio equipment, if any, installed on board the same ship or aircraft; (c) The electrical installation of the amateur mobile station shall be in accord with the rules applicable to ships or aircraft as promulgated by the appropriate government agency; (d) The operation of the amateur mobile station shall not interfere with the efficient operation of any other radio equipment installed on board the same ship or aircraft; and (e) The amateur mobile station and its associated equipment, either in itself or in its method of operation, shall not constitute a hazard to the safety of life or property.

Hamming from your boat can not only be a lot of fun, it can also enhance your boating safety by providing a much-needed communications link in time of trouble. Like any amateur installation in less than ideal circumstances, the typical-shipboard ham station will be limited in both operating convenience and efficiency—but that won't keep any enthusiastic boater/ham off the air. Just listen for W3MR/M on all bands.

reference

1. Harry R. Hyder, W7IV, "Five-To-One Transmatch," *ham radio*, May, 1974, page 54.

ham radio

ham radio BOOKS TAKE YOU

NOVICE RADIO GUIDE

by Jim Ashe, W1E2T



A complete handbook for the beginning amateur. Covers basic communications theory. How to build transmitters and simple receiving equipment. How to set up antennas. Putting your station together, plus valuable appendices. How to learn the code and more. Any beginner will go further faster and have more fun with this exciting new book.

Order HR-NR

144 pages

\$3.50

HOW TO USE INTEGRATED-CIRCUIT LOGIC ELEMENTS

Second Edition by Jack W. Streater

This book was written for those who have not previously used or designed digital logic circuits. It is meant to help them prepare for the broad inroads digital integrated circuits are making. Experimenters will find this book interesting and understandable and will appreciate the fascinating logic circuits which are presented.

Order 21081

Only \$4.50



Brand New — Volumes III & IV

SCANNER-MONITOR SERVICING DATA

Volumes I, II, III & IV

These important books each contain servicing data for several dozen of the most popular UHF and VHF receivers now in use. Last minute information includes schematics, voltages, alignment, part lists, crystal data, pictorials and troubleshooting information.

Volume I contains models from B & K, Browning, Johnson, Midland, Pace, Pearce-Simpson, Penney's, Realistic, Sonar and Teaberry.

Order 06557

Volume II has models by Regency, Electra, Midland, Tennelec and Unimetrics.

Order 06558

* Volume III describes models from Electra, Johnson, Midland, Pearce-Simpson and Regency.

Order 06560

* Volume IV offers equipment by Regency, J. C. Penney, LaFayette, Midland and Unimetrics.

Order 06635

* NEW THIS ISSUE!

Any one volume - \$4.95

Any two volumes - \$9.00

All four volumes

\$16.95

exciting!

order today from

HAM RADIO, Greenville, NH 03048

FROM THE GROUND UP



VHF HANDBOOK FOR RADIO AMATEURS

by *Herbert S. Brier, W9EGQ*
and *William I. Orr, W6SAI*

This big new book covers the field of VHF communications for both the newcomer and the old-timer. Covers such subjects as VHF FM, Satellites, elimination of VHF TVI problems, VHF antennas including special antennas for satellite work, plus a number of interesting construction projects. Be sure to order your copy now.

Order RP-VH

Just \$5.95

THE ARRL ANTENNA BOOK 13th EDITION

Here is the latest edition of this popular standby. Extensively revised, this book covers both the theory and practical application of all types of antennas for all amateur bands. Whether your station is for DXing, ragchewing, or FM this is a must book.

Order AR-AM

Only \$3.00

TEST EQUIPMENT FOR THE RADIO AMATEUR

by *H. L. Gibson, G8CGA*

This beautiful new, hardbound volume sets a whole new standard on this subject for amateurs. Included are chapters on how to build test equipment, chapters on how to use test equipment, plus chapters on the theory of test equipment. You are sure not to be disappointed by this important book.

Order RS-TE

Only \$5.95



LINEAR IC PRINCIPLES, EXPERIMENTS & PROJECTS

by *Edward M. Noll, W3FQJ*

A real blockbuster from popular Ham Radio author Ed Noll, this book devotes nearly 400 pages to linear IC's. Here is a very practical volume aimed at the experimenter with literally hundreds of applications and much valuable background information. Of particular interest are a number of circuits useful in amateur designs including a whole chapter devoted to two way radio. We know this will be a real bestseller so be sure to order your copy today.

Order 21019

Just \$8.95

EW titles



Add 25¢ per book
shipping and handling.

Free shipping 3 or more books.



electronic speed control for RTTY machines

Single-knob
RTTY speed control
permits
instant speed change

In a rash moment I decided to invest in a governor-motor Kleinschmidt TT271 KSR page printer to use for high speed operation. The prospect of 60 to 100 wpm operation for \$40 was just too good to pass up. Much to my pleasant surprise, the governor worked perfectly and the machine generated no rf interference in my receiver. With 100 wpm gears and various governor adjustments it would run from 67 wpm to over 100 wpm and copy was fine at each standard speed. Then I decided to design and build a solid-state motor drive to replace the governor, permitting me to control speed from a console knob.

speed sensor

The first problem was to sense motor speed. For this I made a pulse wheel about 1-3/4 inch (4.5 cm) in diameter

from 0.032-inch (0.8-mm) aluminum sheet (fig. 1) and, after removing the governor mechanism, fastened it to the motor shaft. The motor shaft had a hole which accepted a small machine-screw tap, allowing me to bolt the pulse wheel directly to the end of the shaft. A General Electric H13A1 optical coupler completed the motor-speed sensor. The coupler, which consists of a light-emitting diode (emitter) and phototransistor (detector) with a gap between them, mounted in a plastic housing, is designed for pulse-wheel operation. The emitter is excited continuously and the pulse wheel teeth interrupt the beam to the detector, as shown in fig. 1. I used a 33-tooth wheel with slots made by sawing 1/4-inch

RTTY speed control system mounted on a Kleinschmidt page printer showing one-knob speed control, front, and motor-mounted pulse tachometer, rear.



K.H. Sueker, W3VF, 110 Garlow Drive, Pittsburgh, Pennsylvania 15235

(6.4-mm) radial cuts with a coping saw. Fortunately, the wheel slots need not be made with precision.

circuit

The circuit is shown schematically in fig. 2. Pulses from the tachometer, squared up by transistor Q1, trigger a monostable multivibrator consisting of Q2 and Q3. The monostable multivibrator converts the tachometer output signal to a series of constant-amplitude, constant-width pulses with repetition rate proportional to motor speed. The average voltage resulting from this pulse train is also proportional to motor speed and so can serve as a highly accurate dc tachometer.

Operational amplifier U1 forms a three-pole Butterworth active filter which develops the required dc voltage from the pulse train. This filter configuration was chosen to give good ripple suppression with minimum time delay. Positive dc output current from U1, proportional to motor speed, is compared to a negative reference current derived from the speed switch and adjusting pots. Op-amp U2 switches sharply from *on* (positive output) to *off* (negative output) when the tach-derived current exceeds the reference current. It serves as a highly sensitive speed detector and drives another optical coupler, this time an H15A1. This coupler is similar to the H13A1 but without the mechanical gap so sensitivity is much higher. The coupler switches transistor Q4 in the gate circuit of the triac which, at long last, turns the motor *on* and *off*. This second optical coupler isolates the control circuit from the 120-volt line.

Operation of the triac circuit is directly analogous to that of the governor. The motor voltage is either *on* or *off*, not continuously phase modulated. This permits considerable simplification in the gating circuitry and provides all the sensitivity needed for this type of application. The cycling rate is somewhat slower than that of the governor, however, probably due to the minimum *on*

time limitations of a triac on a 60-Hz line. After working with the control circuitry for a while, you cannot help but admire the simple, rugged and sensitive mechanical governor with which these machines were originally equipped.

The resistors and pots in the speed reference network permit the circuit to

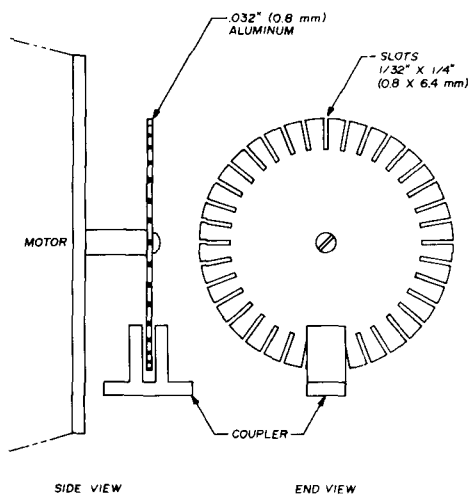

fig. 1. Plan view of the pulse tachometer. The author used a 33-slot wheel for his Kleinschmidt page printer, but suggests 60 slots if this controller is to be used with a Teletype Corporation machine.

be adjusted to each of the standard speeds of 60, 67, 75 and 100 wpm; these correspond to baud rates of 45.45, 50.00, 56.88 and 74.20.¹ Baud rates determine the precise speed ratios required, so a frequency counter can be used to set the speeds. In the Kleinschmidt machine, the motor shaft revolves at 3600 rpm for operation at the wpm speeds marked on the gears. Speeds may also be set by trial and error copy and that is how I did the job.

Operation over the range from 60 to 100 wpm is possible with the 100 wpm gears installed. However, the speed stability at 60 wpm leaves something to be desired. I ended up using the 67 wpm gearing and running the motor up to 5400 rpm for 100 wpm copy. This seems

to pose no particular problem for the motor since it will run much faster at full voltage, even under full load. I doubt that the additional bearing or brush wear is significant in amateur service. The 67 wpm gearing results in nearly normal shaft speed (roughly 3240 rpm) at 60

trigger pulses at the base of Q2. With the 15k feedback resistor in place, the mono-stable pulses at the collector of Q3 must not overlap at the maximum pulse-wheel speed. This may be checked with a scope or by observing the dc voltage at the collector of Q2.

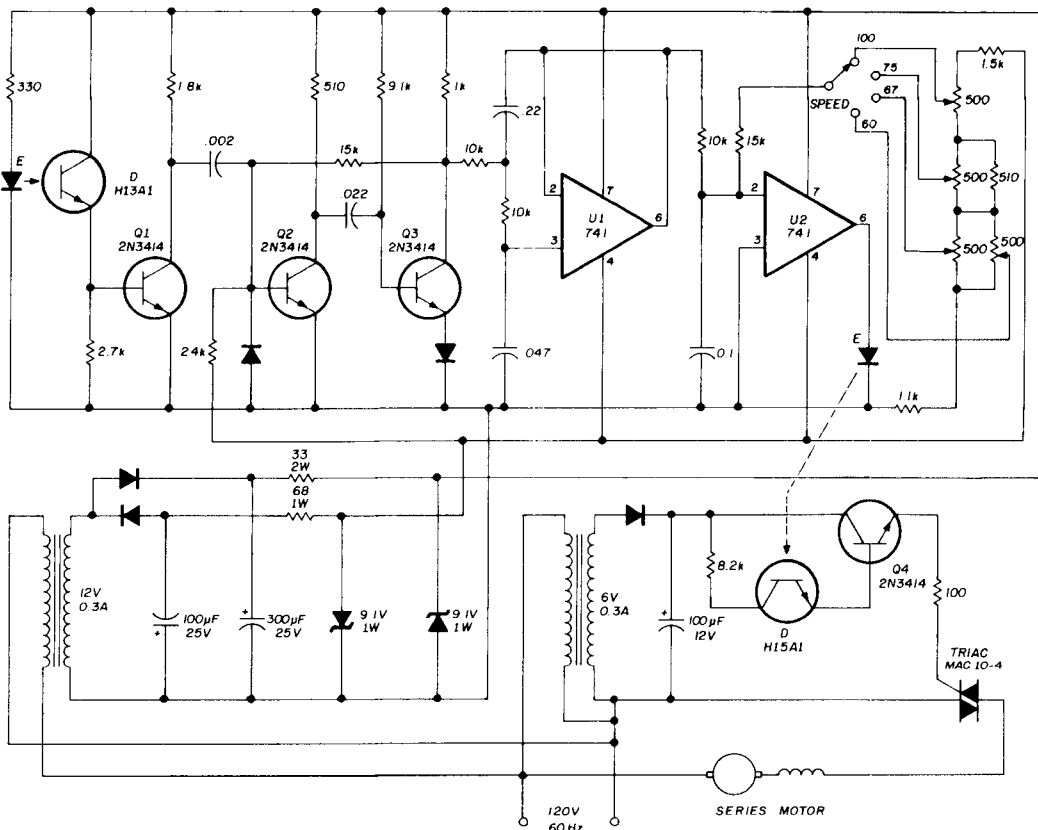

fig. 2. Schematic diagram of the RTTY speed-control circuit. Watch for built-in hash-suppression capacitors in the printer motor circuit, as they can destroy the triac motor driver.

wpm, and motor momentum serves to smooth out speed fluctuations caused by the rapidly clutched load.

adjustment

Some comments on adjustments are in order since no two pulse wheels or photo couplers will be identical. The 330-ohm LED dropping resistor and the 2.7k resistor in the base of Q1 may be changed, if necessary, to produce clean, steady

The voltage should be proportional to pulse-wheel speed over the desired speed range, reaching about 3 volts at maximum speed. Decreasing the 0.022-µF timing capacitor or decreasing the 9.1k timing resistor will narrow the pulses and reduce the average voltage. The best combination is the one which permits the maximum voltage while maintaining linearity to 100 wpm.

The range on the speed pots is deliber-

ately restricted to make adjustment easier. The values shown, together with the 1.1k resistor to ground, allow exact speed *ratios* to be set. Exact speed *settings*, however, may require changing the 1.5k upper divider resistor or the 15k op-amp input resistor to compensate for

amperes. Higher current triacs or better heat sinking would permit the use of this speed control circuit with larger motors. Remember that the triac must supply 5 to 10 times normal current at turn-on while the motor is at zero speed. Also, a larger triac may require additional gate

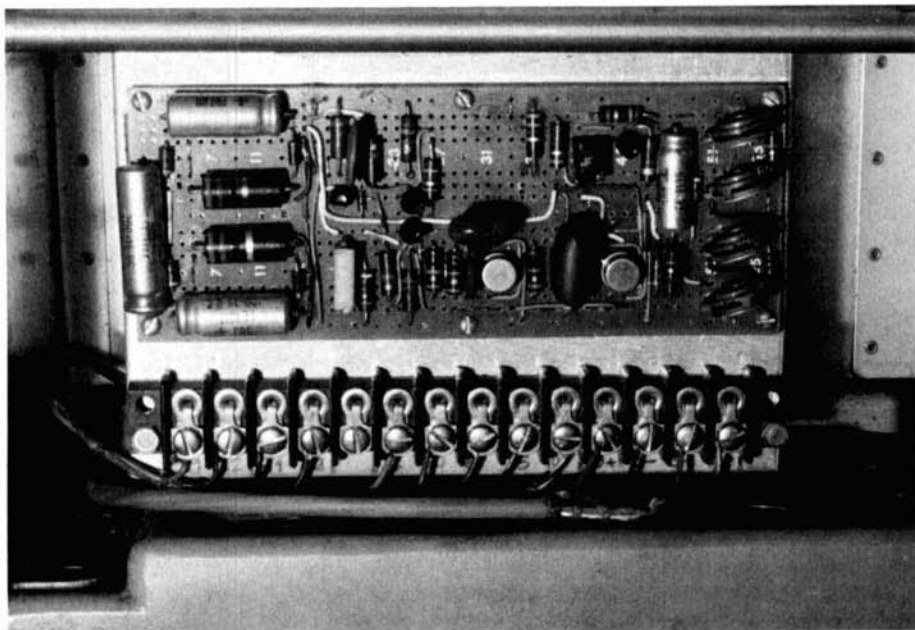

Circuitry for the RTTY speed control system is mounted on small perforated board which is installed on the rear of the page printer.

zener diode tolerances, resistor tolerances or gearing different from that described.

One precaution should be observed regarding the triac: Do not connect a capacitor, even a small one, directly across the triac or load. The surge current at turn-on can instantly destroy the triac. A resistor of at least 22 ohms should be inserted in series with any capacitor which may already be present or which you may wish to add for noise suppression. My unit caused some receiver hash while on the bench, but quieted down completely when installed in the machine and connected to the built-in rf filter. The MAC10-4 triac, mounted to the chassis with the insulating hardware supplied, should handle loads to at least 3

drive and a boost in the gate power supply.

circuit components

None of the components used in this circuit are critical, though the timing resistor and capacitor should be types that are stable. Metal-film resistors and polycarbonate or polystyrene capacitors are suitable. If the GE photocoupler is not readily available, you can build your own using separate LEDs and phototransistors. Nearly any type of npn transistor is suitable for Q1 through Q4 (I used 2N3414s). The same is true for the diodes. Signal-type silicon diodes should be used in the transistor circuits, and lead-mount power diodes of at least

50-volt PIV in the power supplies. The op-amps may be individual 741 units or the 747 dual 741/741; pin numbers are shown for the TO5 type 741. Surplus units are available at attractive prices from various suppliers. The 6- and 12-volt power transformers are available from

Replacement series motors are available from advertisers in *RTTY Journal* and *ham radio* for about \$15.00.

In summary, my variable-speed Kleinschmidt machine has now been on the air for several months. Those patient hams who have coped with my typing have



Author W3VF using the variable-speed Kleinschmidt RTTY machine at his station in Pennsylvania.

Radio Shack for about \$1.50. Cost of the parts should not exceed \$25, even if most are bought new.

I am not yet an expert on the Teletype Corporation machines except to note that the older ones, at least through the Model 26, have 1800 rpm synchronous motors. Teletype governor motors are in the same general speed range. This would suggest the use of a pulse wheel with at least 60 slots in order to get the tach frequency up near the design value. With that one change, the control unit described here should be suitable for Teletype machines with series governor type motors. It is *not* recommended for synchronous motors.

reported no speed problems, and the copy has been excellent on my end. Commercial stations have been copied at all four speeds with perfect results as far as speed is concerned. Reworking surplus machines and building controls of this sort may be viewed by some as an unrewarding chore, but the pleasure of achieving instant speed change by twisting a little knob made it all worthwhile for me. Now for that FRXD20 in the corner . . .

reference

1. "Principles of Telegraphy—Teletypewriter," NAVSHIPS 0967-255-0010.

ham radio

Explore the world of RTTY... with sophisticated equipment from HAL.



The RVD-1002. The silent, reliable RTTY video display unit from HAL.

The revolutionary HAL RVD-1002 RTTY video display unit "prints" an RTTY signal from any TU at the four standard data rates (60, 66, 75 and 100 WPM), using a TV receiver with slight modification. Or it will directly feed a TV monitor. Power consumption is low, thanks to the RVD-1002's solid-state construction. So turn on to silent, trouble-free RTTY — with the RVD-1002.

Price: \$575 ppd, USA. Air shipment \$10.



The silent RTTY keyboard — that's the HAL RKB-1.

The RKB-1 TTY keyboard is loaded with features to make sending RTTY easy and fun. You get automatic letter/number shift at all four speeds, typewriter keyboard layout, and no clutter! The loop keying transistor is isolated from other keyboard circuits — wire it into any convenient point in your loop. Plus TTL logic, glass epoxy PC board, commercial grade keyswitches and more.

Price: \$250 Assembled, ppd USA. Air shipment \$5.



RTTY — and CW on one keyboard! The HAL DKB-2010.

All solid-state. Transmit at data rates of 60, 66, 75 or 100 WPM at the flick of a switch. Complete alphanumeric keys, 15 punctuation marks, 3 carriage control keys, 2 shift keys, break key, 2 character function keys, a "DE-call sign" key, even a "Quick brown fox..." test key.

The DKB-2010 is equally versatile in the CW mode, with complete alphanumeric and punctuation keys, speeds from 8-60 WPM, and a "DE-call sign" key. The DKB-2010 includes a three-character buffer operation in either the RTTY or CW mode. Optional 64 or 128 key buffer also available.

Price: \$425 Assembled, \$325 Kit, ppd USA.
64 key buffer \$100, 128 key buffer \$150.
Air shipment \$10.



Commercial quality on an amateur's budget — the HAL ST-6 TU

Every amateur who knows his RTTY respects the ST-6 terminal as being the best. Autostart operation, an antispaces feature and switch selection of 850 and 170 Hz shifts are standard. Circuitry is state-of-the-art, including DIP IC's on plug-in PC cards. Filters and discriminators are designed for standard RTTY tones. A 425 Hz shift discriminator is an option which allows superior reception when copying commercial press transmissions. Another option is the AK-1 audio frequency shift keyer for input to an SSB transmitter. The ST-6 and its options are available in assembled or kit form. Cabinet not included in kit.

Price: ST-6 \$310 Assembled, \$147.50 Kit, ppd USA.
425 Hz Discriminator \$40 Assembled, \$29 Kit, ppd USA.
AK-1 AFSK \$40 Assembled, \$29 Kit, ppd USA.
Air shipment: Assembled ST-6 with any or all options \$10, ST-6 Kit \$4, 425 Hz Kit \$1, AK-1 Kit \$1.



HAL Communications Corp.
Box 365, Urbana, Illinois 61801
Telephone: (217) 359-7373

Enclosed is \$_____ for: RVD-1002 RKB-1 DKB-2010 ST-6
Please specify Assembled Kit Options _____
Please send me more information on the following HAL products
 RVD-1002 RKB-1 DKB-2010 ST-6
 Complete HAL catalog

Name _____ Address _____ Call Sign _____

City/State/Zip _____ Illinois residents add 5% sales tax.

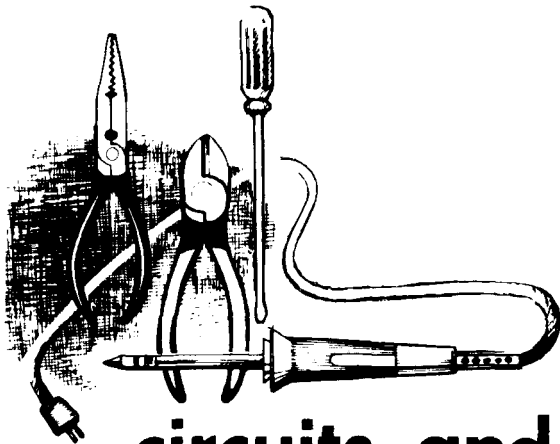

circuits and techniques

ed noll, W3FQJ

battery power

Amateur radio is entering a new era of battery operations. Battery-powered, hand-held and portable fm transceivers are just one example. Battery-powered QRP operation is also popular. Look for a new emphasis on battery operation during field-day activities. In fact, the very changeover from vacuum tube to all solid-state electronic gear has awakened new interest in battery applications.

The energy crisis is the catalyst for further expansion. The battery-powered bus has made a successful debut; the battery-powered family run-about waits behind the oil curtain. However, the real expansion is likely to be within the framework of solar power. Batteries will carry us through the night.

The all solar-powered ham station is no wild fantasy. The primary-cell battery is a one-shot affair. A typical example is the common zinc-carbon battery. After its chemical energy has been converted to electrical energy it is discarded. The secondary-cell battery is rechargeable. Its energy can be drained off and then

resupplied by recharging the battery from a source of electrical power such as a solar-energy converter or a standard battery charger. The most well-known secondary battery is the lead-acid battery used in your automobile.

When your battery-powered ham gear is removed from your car, the two most common secondary batteries are the nickel-cadmium and dry gelatin-electrolyte, lead-acid types.

battery ratings

Be it a primary or secondary type, the two most common battery ratings are voltage and ampere-hours (or milliamperere-hours). Voltage is no problem because there are a wide variety of types available according to voltage. There are many 12-volt types, matching the most common voltage requirement of solid-state radio gear. Other voltages can be obtained with the proper series-parallel groupings of standard-voltage batteries. The parallel connection, of course, increases current capability and available ampere-hours.

The ampere-hour or milliamperere-hour ratings of batteries are usually based on 10 or 20 hours of continuous operation. For example, a popular 12-volt nickel-cadmium battery has a 1.2 ampere-hour rating. This is based on a 10-hour discharge time and a cut-off voltage of 11 volts. What continuous current demand could be made on the battery over this

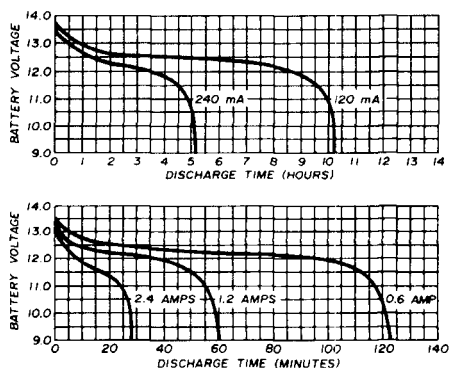

fig. 1. Discharge characteristics of a typical nickel-cadmium secondary battery (courtesy Eveready).

10-hour period? Since the ampere-hour rating of the battery and operating time are known,

$$I = \frac{\text{Ampere-hour rating}}{\text{Time}} = \frac{1.2}{10}$$

$$= 120 \text{ milliamperes}$$

The ampere-hour rating is less when there is a greater current demand and is likely to be more for a lesser current demand. Graphs and charts are available for vari-

indicating that the ampere-hour capacity of the battery is somewhat less than its 1.2 rating for a 10-hour period. The bottom set of curves shows the discharge time in minutes when a high current demand is made on the battery. Note that, for a current demand of 1.2 amperes, the 11-volt level is reached after a time interval of 55 minutes.

An example of a battery chart is given in **table 1** for the popular D-size zinc-

table 1. Hours of life chart for Eveready 950 D-cell.

schedule	starting drains (mA)	cutoff voltage				
		0.8V	0.9V	1.0V	1.1V	1.2V
2 hours/day	10	525	500	475	450	430
	20	295	270	260	240	210
	30	210	185	175	155	135
	50	125	113	103	89	77
	100	57	50	45	35	29
	150	33	29	25	18.5	14
	200	21.5	18	15.5	11.5	8
	250	15	12	10	7.2	4.5
4 hours/day	300	11	8.5	7	5	2
	10	660	620	580	530	470
	20	330	310	290	260	230
	30	220	200	185	155	125
	50	123	108	96	81	64
	100	50	41	36	30	22
	200	18	13.5	12	9	5.2
	300	8	6	3.5	3	2
8 hours/day	10	700	660	620	560	460
	20	340	310	270	230	180
	30	210	180	150	130	100
	50	105	82	70	60	50
	100	39	28	23	18	13.5
24 hours/day	10	1050	745	600	500	370
	20	360	260	210	165	125
	30	200	145	115	88	65
	50	92	67	52	40	29
	100	32	24	18.5	13.5	9.6
	200	11.5	8.5	6.4	4.5	3.2
	300	6	4.5	3.5	3	2

ous commercial batteries and from these you can determine primary battery life or when a secondary battery needs to be re-charged. A typical graph is shown in **fig. 1**.

The upper curve shows the 120- and 240-milliamper discharge curves. Notice, on the 120-mA curve, that at the end of 10 hours the battery's voltage has declined to 11 volts. If the current demand is doubled to 240 mA, the 11-volt level is reached after something less than 5 hours,

carbon (LeClanche) dry battery. Battery life is related to how many hours per day it is switched into operation. Take a current drain of 100 mA as an example. Note that, for 2-hours operation per day, the battery potential will drop to 1.2 volts after 29 hours. When the battery is operated continuously with a current drain of 100 mA its anticipated life to cutoff potential of 1.2 volts is only 9.6 hours.

The 1.5-volt LeClanche dry cells have been more or less standardized as to physical size and capacity. The data of table 2 are typical. Ratings are based on an operating temperature of 70°F, two

current drain of 100 mA for two hours per day is assumed, the service life will be 45 hours. This can be verified from the specific chart for a D-cell given in table 1. These basic cells are used to construct

table 2. Operating-hour capacities of standard Leclanche dry cells (courtesy Eveready).

cell	starting drain (mA)	service capacity (hours)	cell	starting drain (mA)	service capacity (hours)	cell	starting drain (mA)	service capacity (hours)
N	1.5	275	105	0.4	210	143	2	190
	7.5	52		2	30		10	40
	15	24		4	8		20	15
AAA	2	290	108	0.5	435	145	2	510
	10	45		2.5	103		10	105
	20	17		5	51		20	43
AA	3	350	109	0.6	710	146	2	560
	15	40		3	155		10	115
	30	15		6	75		20	50
B	5	420	112	0.7	210	148	2	610
	25	62		3.5	35		10	130
	50	25		7	12		20	70
C	5	430	114	0.7	300	162	3	550
	25	100		3.5	57		15	150
	50	40		7	25		30	65
D	10	500	116	0.8	475	163	3	600
	50	105		4	98		15	165
	100	45		8	49		30	72
E	15	400	125	1	500	165	3	770
	75	70		5	105		15	200
	150	30		10	45		30	90
F	15	520	127	1	475	172	5	780
	75	105		5	150		25	200
	150	45		10	72		50	90
G	15	1000	132	1.3	275	175	5	1000
	75	150		6.5	40		25	260
	150	65		13	16		50	110
6	50	700	133	1.3	450	176	10	910
	250	150		6.5	80		50	165
	500	70		13	35		100	63
104	0.4	200	135	1.3	450	208-1	3	370
	2	28		6.5	108		15	75
	4	7		13	52		30	35
213-1	3	550	240-5	5	1000	260-6	10	1900
	15	110		25	430		50	445
	30	50		50	180		100	210
240-2	5	630	250-5	5	1800	335	10	375
	25	270		25	750		50	78
	50	110		50	375		100	37

operating hours per day and a cut-off voltage of 1 volt for the first ten cells listed and 0.8 volt for the remaining cells except numbers 176 and 335, which are based on a cut-off of 1 volt.

Use a D-size cell as an example. If a

many of the higher voltage and higher current LeClanche dry-cell batteries. The F-type cell, for example, is popular in the construction of several popular communications batteries. To determine the service life when cells are connected

in parallel you need only divide the current drain by the number of parallel cells. Of course, the number of cells connected in series determines the final voltage and equals the number of cells times the voltage per cell.

A chart such as that shown in **fig. 2** gives more detail on the capacity of an individual cell type. In this example, service life in hours is plotted against current demand for various values of cut-off voltage.

What would be the service life in hours to a cut-off of 1.2 volts with a 50 mA current drain? From the 1.2-volt curve in **fig. 2** this can be determined as 120 hours. Figures are based on four hours of operation per day (this could be typical for many of the more active radio amateurs).

What would happen to the service life if two of these cells were connected in parallel, placing a current demand of only 25 mA on each cell? The 25 mA line in **fig. 2** intersects the 1.2-volt curve at approximately 270 hours. Note that this more than doubles the service life expected from a single cell.

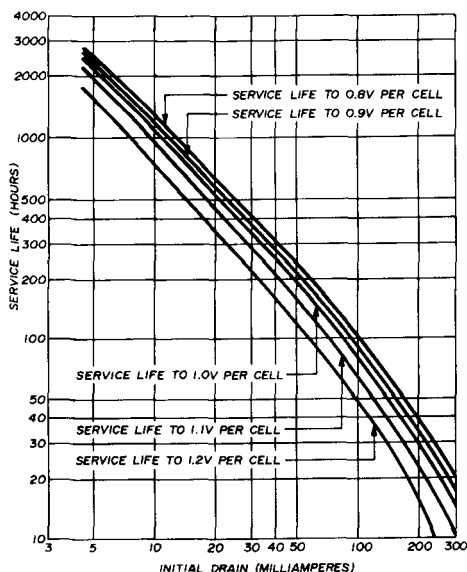

2. Estimated service life for F-type batteries when discharged 4 hours per day at 70°F (courtesy Burgess Battery).

Temperature has a decided influence on battery discharge. In the D-type carbon-zinc cell example of **fig. 3** the decline to 1 volt occurs in about 1 hour at 70°F while the drop to 1-volt occurs at

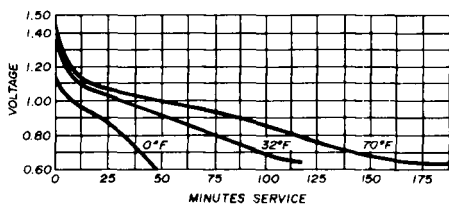

fig. 3. Temperature influence on rate of battery discharge (courtesy Eveready).

32°F in only one-half hour. Figures assume a current demand of 667 mA.

basic battery types

In experimenting with solid-state circuits and in QRPP operations of 1 watt and under, I usually use the common lantern battery. The 12-volt Eveready 732 and Burgess Radar-Lite TW2 consist of eight F-type dry cells in series. The data of **fig. 2** are appropriate.

A current drain of 100 mA corresponds to an available power of 1.2 watts. If the lantern battery were subject to four hours of continuous operation per day the individual cell voltage would fall to 1.2 volts after 50 hours of operation.

This seems to be a short time. However, a number of additional factors must be considered. Do you operate four hours per day? How many hours per day would the 1.2-watt demand be made on the battery? This is important when you consider that your receive time is always longer than your transmit time. You do a substantial amount of listening around the band and then, depending upon whom you are in contact with, the transmit and receive times can be estimated at 50%. Furthermore, in CW operation you are placing an intermittent demand on the battery rather than asking for a continuous 1 watt of power. It may well be that during a 4-hour operating period your key may be *down* for one

hour or less. Thus, your actual battery life may be 4 to perhaps as high as 6 times greater than is suggested by the 50-hour life figure. This represents 200 to 300 hours of operating time and, in terms of the usual ham QRPP activity, you are talking about months of operation.

Two lantern batteries in parallel more than double the operating time. Or you can step up to the Eveready Hot-Shot 1463. This battery uses 16 G-type cells, **table 2**, connected in two parallel strings of eight. Since there are two sets in parallel, you must either halve the current values given under *starting drain* or double the *service capacity hours*, to obtain an approximate service capacity figure of the G-type battery data of **table 2**. This actual figure will be somewhat greater than the chart indicates because, as pointed out, the service capacity more than doubles when current drain is halved.

A rechargeable battery designed specifically for electrical and electronic applications is the alkaline-manganese dioxide type shown in **fig. 4**. Although rechargeable, their electrochemical systems can be hermetically sealed. Such batteries are



fig. 4. Rechargeable alkaline-manganese battery type 564 (courtesy Eveready).

maintenance free and they operate in any mounting position. Electrodes are made of zinc and manganese dioxide while the electrolyte is potassium hydroxide.

These cells come in two forms, meeting the physical dimensions of the D- and G-type dry cells. The characteristics of the Eveready D and G cells are given in **table 3**. Note the voltage values and the high ampere-hour capacities of these cells.

Higher voltage and/or higher discharge current capacities are obtained by using these fundamental cells in series and parallel groupings. This 564 battery, shown in **fig. 4**, uses nine G cells in series and has a 5 ampere-hour capacity that can deliver 1.25 amperes for a period of four hours without recharge. We are now talking about more than 10 watts of available power and, in fact, 10 watts continuous for a period of four hours. As mentioned previously, four hours of continuous key-down operation usually corresponds to more than 12 hours of continuous operating time.

Of course, you can anticipate many days of operation without a recharge. Considering that the battery can be recharged 25 or more times, there is adequate energy available to last a year or more for even the most active 5- to 10-watt QRP operator.

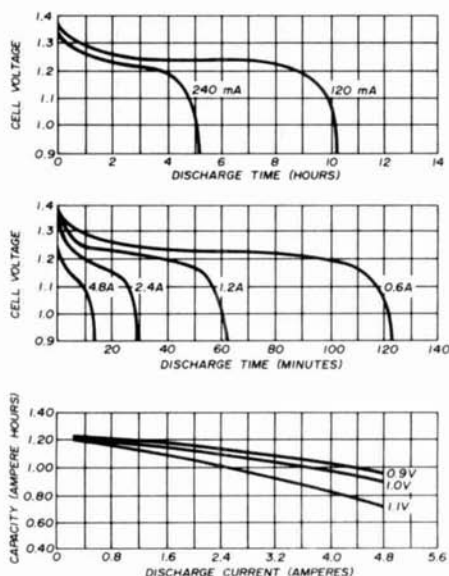

fig. 5. Characteristics of a nickel-cadmium cell (courtesy Eveready).



fig. 6. Sealed six-volt nickel-cadmium battery (courtesy Eveready).

The rechargeable nickel-cadmium battery is a popular secondary battery for use in electronics and electrical systems. Again, it is a shielded battery and there are no corrosive fumes or the need for adding electrolyte. An especially attractive advantage of the nickel-cadmium battery is its nearly constant discharge potential. The discharge-charge cycle may be repeated as many as 300 to 500 times.

table 3. Characteristics of basic alkaline-manganese cells.

cell size	nominal voltage	average operating voltage	rated ampere-hour capacity	maximum recommended discharge current
D	1.5	1.0 - 1.2	2.5	0.625 ampere
G	1.5	1.0 - 1.2	5.0	1.25 ampere

This means that a nickel-cadmium battery selected for most amateur applications will have an exceedingly long life if it is not abused.

Eveready nickel-cadmium 1.25-volt cells are available in button (20-300 milliampere-hours), cylindrical (150-4000

mA-hours), and rectangular (6-23 ampere-hours) types. Individual cells are welded together to obtain higher operating voltages. The cell voltage-discharge time characteristics of a typical cell are given in fig. 5. Note that the voltage on discharge holds rather constant over the discharge time until near the break in the curve. It is not advisable to let the cell voltage drop below 1.1 volt before recharge is initiated. In so doing the cell voltage is held up and the life of the battery is extended. The lowest graph shows the capacity-discharge current characteristic of the cell. For example, it shows that with a 1.2-ampere discharge current and a cutoff of 1.1 volt, the battery has an ampere-hour capacity of about 1.12 ampere-hours.

The Eveready N86 battery consists of ten of these cells connected in series to obtain 12.5 volts. On the basis of a 10-hour discharge at a rate of 120 mA, the capacity of the battery is 1.2 ampere-hours. Its discharge characteristic is shown in fig. 1. Note that the battery voltage drops to 11 volts near the 10-hour calibration line when the current demand is 120 mA.

There are many nickel-cadmium battery types. The Eveready 1007, fig. 6, is a four ampere-hour, six-volt battery that is completely encased. On a 10-hour basis it would have a rated current of 400 mA. It includes a socket for plugging in a companion charger. The Burgess CD33 is a 6-volter of lantern-battery size with a 2 ampere-hour capacity and includes a built-in charger.

The nickel-cadmium battery can be trickle-charged and kept up to full charge just as you would maintain an ordinary lead-acid storage battery. Usually the trickle-charge current is about one-quarter of the rated discharge current.

Next month's column covers battery chargers and the increasingly popular gelatin electrolyte lead-acid secondary battery. I will also discuss how a solar power converter can be used to trickle-charge or fully charge the various types of rechargeable batteries.

ham radio

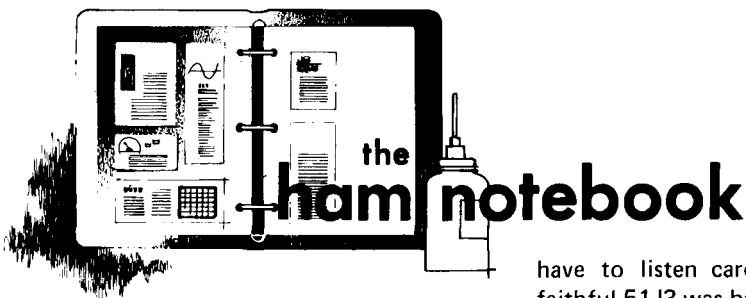

temporary fix for noisy volume controls

Gain control pots eventually become intermittent at the point of maximum use and thus can make a fine piece of equipment almost unusable. This happened to the audio gain control in my Collins 51J3, and having torn the receiver apart once before to work on the PTO I had no desire to go through all that work again just to change a noisy potentiometer.

Since a worn pot manifests itself by sudden jumps in level, distortion and bursts of noise, I reasoned that a "fix" that had a stabilizing effect at the tube grid might suppress the problem sufficiently to make the receiver usable again. Many audio circuits resemble the Collins circuit shown in fig. 1, so my first attempt was to put a fixed resistor from the wiper (tube grid) to ground. This did exactly what I wanted, and after a little experimentation to find optimum value (5k still provided enough audio to drive me from the room, yet reduced the effect of the noisy spot to the point where I

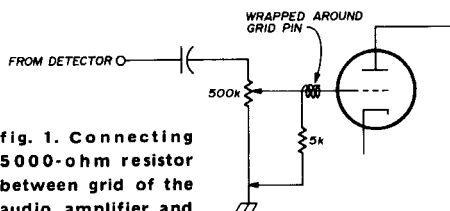

fig. 1. Connecting 5000-ohm resistor between grid of the audio amplifier and ground substantially reduced noise generated by worn 500k volume control.

have to listen carefully to find it) my faithful 51J3 was back in business.

Being essentially lazy, and seeing that this was a "temporary" repair anyway, I didn't even pull the receiver out of the cabinet to add the resistor. Instead, I simply wrapped a piece of wire around the grid pin of the audio tube, ran the wire up alongside the tube and out through the top of the shield, and soldered the 5k resistor to it. The other end of the resistor is grounded by a handy nearby wing nut. It may not look very nice, but it sure works well—and someday, when I *really* have to tear into the receiver, I *do* plan to replace that noisy pot!

Joe Schroeder, W9JUV

counted frequencies

In some configurations, a frequency counter may not properly show the received (or transmitted) frequency. I refer to those cases where a *clarifier* or variable bfo may be used. For example, in the Collins 75S-3 receiver the variable bfo changes the beat-note on CW. However, the 32S-3 exciter in transceive continues to use its own crystal bfo. Thus, a receiver frequency counter may not correctly show the transmitted frequency nor the frequency to which the receiver is tuned.

Similar peculiarities can occur in the use of the clarifier, a term used in Yaesu and some other designs. The nature of these devices should be studied before a counter frequency is relied upon to show the frequency that you are interested in.

Bill Conklin, K6KA

Introducing the Atlas-180

SOLID STATE SINGLE SIDEBAND TRANSCEIVER.
180 WATTS P.E.P. INPUT . . . 20, 40, 80 and 160 METER



Illustrated with optional plug-in Mobile Mount.

THE IDEAL MOBILE RIG.

Only 3½ in. high, 9½ in. wide, 9½ in. deep . . . Operates directly from 12-14 volts DC . . . All Solid State Modular Construction, No transmitter tuning, Built-in speaker. All the necessary features, power, and performance for only **\$479**



AC CONSOLE

Illustrated with Atlas-180 plugged in. A handsome desk top station with front facing speaker and space for adding VOX and other accessories.

Model AR-117 for 117 volts, 50-60 cycles **\$119**

- Deluxe plug-in Mobile Mount: \$40
- Standard Mobile Kit: \$10
- Mobile Antenna Matching Transformer \$24

Other accessories to be announced.

AMERICAN MADE AND GUARANTEED BY



ATLAS
RADIO INC.

5580B El Camino Real Phone (714) 729-8985
Mail Address: P.O. Box A, Carlsbad, California 92008

Sold only by Atlas dealers. See him soon for complete details, or drop us a card and we'll be glad to mail you a brochure and dealer list.

73 Herb Johnson W6QKI

new products

two-meter fm sets



General Aviation Electronics (Genave) has introduced a new vhf fm system called *Mobiline*. This system, which consists of *Mobiline I* and *II* two-way fm mobile units and a variety of fixed base stations, offers considerable system flexibility. *Mobiline I*, for example, is designed for use in lightly populated areas with low signal density communications environments. These units accommodate two communications channels in the frequency range from 143.9 to 173.4 MHz, and are equipped with separate volume and squelch controls and transmit indicator light. A plug-in microphone and mobile mounting bracket with anti-theft device are included at no extra charge.

The *Mobiline II* provides the same basic capability as the *Mobiline I*, but has additional circuitry to permit use in heavily populated, high signal density communications environments. Refinements in the receiver section provide higher selectivity, improved spurious response and superior adjacent channel

rejection. The *Mobiline II* like *Mobiline I*, features nominal 25-watts output power and 0.5 μ V sensitivity for 20 dB quieting.

Either of these two radios is easily adaptable to fixed based station use. The Genave base-station packages include a stainless-steel 3-dB gain antenna with 50-feet of RG-8/U coaxial cable and connectors. Also included is the standard hand microphone (optional desk-type microphones are available starting at \$34.95). Another important option is the *MobilPack* portability accessory. This allows the *Mobiline* owner to operate portable in the field or in vehicles without electrical systems. The *MobilPack* will provide a minimum of 24 hours of service on full charge and costs \$124.95. Also available for the Genave *Mobiline* system is a sub-audible tone squelch system called *MobilGuard*.

The *Mobiline I* is priced at \$319.95, the *Mobiline II* is \$399.95 (including one channel). For more information write to General Aviation Electronics, 4141 Kingman Drive, Indianapolis, Indiana 46226, or use *check-off* on page 94.

test equipment for the radio amateur

Techniques of measurement and instrumentation have progressed rapidly in recent years, with the result that many very sophisticated methods of measurement are now available to the serious radio amateur. The development of modern semiconductor devices has meant that many items of equipment that were previously barred from the amateur workshop on the grounds of complexity, cost or size, have suddenly become a realistic possibility.

This new book by H.L. Gibson, G8CGA, published by the RSGB, explains in detail the theory behind modern measurement techniques, and goes on to describe many items of equipment of special interest to the amateur experimenter and home builder. Many of the construction articles feature instruments that have not before appeared in

print. Readers are taken through the basics of indicating and electronic instruments, and on to the techniques of frequency, power and noise measurement using up-to-the-minute components and methods. Included are chapters on meters, electronic instruments, dip oscillators, frequency and rf power measurements, noise measurement, antenna and transmission-line measurements, signal sources and attenuators, oscilloscopes, swept-frequency measurements, and components, vacuum tubes and transistors.

The section on electronic instruments includes circuit details on vacuum-tube voltmeters, fet voltmeters, transistor multimeters, diode probes and input attenuators. The chapter on dip oscillators includes valuable information on using the instrument as well as construction details for several solid-state units. The frequency measurement chapter covers frequency standards, crystal calibrators, digital counters, absorption wavemeters, harmonic indicators and a simple audio-frequency meter.

The chapter on rf power measurements includes data on dummy loads, thermal converters, rf ammeters, rf voltmeters, thermistor/bolometer bridges and directional wattmeters. Noise sources, noise generators, noise factor comparators and routine noise-figure checks are discussed in the chapter on noise, and vswr meters, vhf/uhf reflectometers, field strength meters and noise bridges are covered in the chapter on antenna measurements. Also described in the book are a rf signal generator, an audio signal generator, a two-tone test oscillator, oscilloscopes, modulation monitors, i-f sweep generators, an RCL bridge, a capacitance meter, a logic tester, a fet mutual conductance tester and many others. The reference data section includes much useful electronic and mechanical data as well as instructions for temperature and air-flow measurements. Hardbound, 132 pages. \$5.95 from Ham Radio Books, Greenville, New Hampshire 03048.

NES

NURMI ELECTRONIC SUPPLY

Department 13
1727 Donna Road • West Palm Beach, Florida 33401
PHONE — (305) 686-8563

MALLORY

**PTC 205
EQUIVALENT TO
HEP 170**

THE "DO EVERYTHING" 2 1/2 AMP. 1000 VOLT DIODE
10/\$2.50 100/\$20.00

RCA 40673's

THE MOST POPULAR DUAL GATE PROTECTED MOS FET around. Good to over 400 MHZ. We got 'em and you get 'em for only... **BACK IN STOCK**... 5/\$6.00

RG-174/U

WE WENT THROUGH 20 MILES OF IT LAST TIME!

We are authorized Belden Distributors and new shipments have come in from the factory. Split a 500' spool with a friend and save \$8555

BELDEN NO. 8216 100'/\$5.25 — 500'/\$19.30

RF POWER TRANSISTORS

We did it again. All brand new with standard markings and most were manufactured this year. A major manufacturer dropped his RF power line and we bought his inventory.



2N5689	3 Watts Out	\$ 3.50	2N6080	4 Watts Out	5.00
2N5690	10 Watts Out	8.00	2N6082	25 Watts Out	10.00
2N5591	25 Watts Out	12.00	2N6084	40 Watts Out	15.00

All are Silicon NPN and power output ratings are good to 175 MHZ. Hurry! Some quantities are limited.

KEYSTONE PERF BOARD

G-10 Glass Epoxy
Perf Board 3.64" Thick

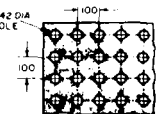

UNCLAD			COPPER CLAD ONE SIDE		
No.	Size (in.)	Price	No.	Size (in.)	Price
4229	2 x 4 1/2	\$.85	4238	2 x 4 1/2	\$1.35
4230	2 x 6	1.09	4239	2 x 6	1.85
4231	4 1/2 x 6	1.55	4240	4 1/2 x 6	3.20
4232	17 x 6	5.75	4241	17 x 6	6.70

PUSH-IN TERMINALS For .042 DIA. HOLES

The terminals easily press fit into a .042 in. dia. hole without staking or the base may be flared for permanent installations. Ideally designed for use in micro-circuitry to support components when space is at a premium.

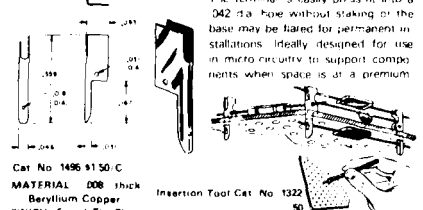

Cat. No. 1496 \$1.50 C
MATERIAL .008 Thick
Beryllium Copper
FINISH Fused Tin Plate

Insertion Tool Cat. No. 1322
50

RF RELAY

Designed to handle 200 watts to 450 MHZ 12 VDC coil. DPDT. The nicest RF relay we have ever had. Only about 1 1/4" cube. Super low VSWR. Satisfaction guaranteed.

Only \$4.95 or \$17.00

ARCO/EL MENCO TRIMMERS

400	\$ 55	421	\$ 55	428	\$1.26	464	\$ 69
402	55	422	55	429	1.26	465	89
403	67	423	64	460	37	466	97
404	81	424	80	461	32	467	1.04
405	1.01	425	85	462	52	468	1.20
406	1.04	426	1.01	463	64	469	1.22
420	58	427	1.12				



WE GUARANTEE WHAT WE SELL!!!
We ship UPS whenever possible. Give street address. Include enough for postage, excess refunded in cash. Florida residents include 4% Tax.

NEW AND DIFFERENT!!



The all new T_{doc} manual for electronics experimenters and hobbyists ---

More than two years in the making, T_{doc} has gathered the most practical and usable data from industry, the U. S. Patent Office, DOD, NASA, NTIS (National Technical Information Service) and others. Jam-packed with all the data needed by the hobby experimenter at the bench. From theory refresher to applications diagrams, device characteristics, tables and formulas, charts and graphs -- hundreds upon hundreds of illustrations.

A High-Density Modular Document

No wasted space or words. Separate sections are removable in loose-leaf fashion -- books within a book -- mounted in a rugged binder, big enough to hold other T_{doc} publications -- or your own notes.

Just by way of example, the section on hand soldering was boiled-down from the practices of the American Welding Society -- Committee on Soldering and Brazing; NASA, USN, solder manufacturers, the Bell Telephone System and others. The section contains everything you need to know about solder, fluxes, soldering tools and techniques.

There are over 100,000 words covering theory and application of semiconductor devices -- diodes, transistors, the SCR/TRIAC, digital and linear integrated circuits, operational amplifiers, voltage regulators, counters and decoders, and much, much more.

Sections also treat the vacuum tube and CRT, capacitors and electrostatic devices, relays and switches, electromechanical devices and mechanical movements, energy sources, cable and wire, +++++

Update Without Annual Replacement

No need to buy a whole new book every year to keep abreast of information in the field; the "book within a book" style permits you to update only as needed.

There has never been another manual like it. That's why we undertook to put it together!! Once you have had a chance to put the manual to use, you'll start enjoying electronics as a hobby, with fewer unfinished projects that could have been completed had there not been an information gap!

Electronics Bench Manual

**Introductory Price: \$17⁹⁵ Postpaid
In U.S.A.**

Send check or money order marked
"EBM" with your name and address
to:

TECHNICAL DOCUMENTATION

BOX 340

CENTREVILLE, VA 22020

703-830-2535

Virginia residents please add 4% sales tax.

function generator



Tucker Electronics Company has announced the first two instruments of what is expected to be a comprehensive new series. The model 300A is a 0.1- to 1-MHz basic function generator offering 10-volt p-p output into 50 ohms and less than 2% sinewave distortion. The instrument provides sinusoidal, square and triangular wave switched outputs and a corresponding sync output. Dc offset of ± 2.5 volts is standard in the small, portable unit.

The second instrument is called the model 310A and adds variable pulse to the basic functions of the model 300A. The 310A's TTL compatible pulse can be varied from 1- μ s to 10-millisecond pulse width and has rise and fall times better than 25 nanoseconds. All the standard 300A features are included.

In addition to an exceptionally low sale price, each instrument can be rented with an excellent purchase option. The Tucker 300A is priced at \$195.00 (rental rate \$19.50/month) while the Tucker 310A is priced at \$295.00 (rental rate \$29.50/month).

Tucker Electronics Company is best known as the world's largest distributor of reconditioned test instruments with an inventory exceeding 15,000 instruments. Tucker currently sells no less than 18 lines of new instruments including Weston Instruments, T.R.I. Corporation, Philips and several other well known lines.

For more information, write to Tucker Electronics Company, Post Office Box 1050, Garland, Texas 75040, or use *check-off* on page 94.

WE GOOFED!

The wrong address was given in the advertisement for
ERICKSON COMMUNICATIONS
 On Page 71 in the July issue

The correct address is:
ERICKSON COMMUNICATIONS
 3501 W. JARVIS
 SKOKIE, IL. 60076 (312) 677-2161

Come to Vermont

1974 INTERNATIONAL FIELD DAY
AUG. 11, OLD LANTERN, CHARLOTTE, VT.

Many activities, contests, camping and more

Details from
 Bob Hall, W1DQO, Gen. Greene Rd.
 Shelburne, Vt. 05482



tri-tek, inc.

P. O. Box 14206, Dept. H
 Phoenix, AZ 85063

8220 MEMORY 8 bit (4x2) content addressable memory. TTL and DTL compatible. For use in data-to-memory comparison, pattern recognition, cache memory, auto correlation, virtual memory, learning memory. New, house numbered. With Data. IN 16 pin DIP. \$6.00 ea., 10 for \$45.00

8038C VCO WAVEFORM GENERATOR. New, factory parts, full specs. \$5.75, 2 for \$10.50, 10 for \$50.00

MM5314 CLOCK CHIP. Full specs. \$9.50

All orders postpaid. Minimum \$5 U.S., \$15 foreign. Latest lists, 10¢ stamp. Please ADD INSURANCE.

radio communication

Great Britain's most popular amateur magazine. The official publication of the RSGB. Learn what English amateurs are building, learn what they are doing.

\$12.50 per year (12 issues)
 Includes RSGB Membership

HAM RADIO
 GREENVILLE, NH 03048

SAROC

going home to the Sahara

Special Air Fare from selected cities.

JANUARY 2-5, 1975

Box 945, Boulder City NV 89005



GREGORY ELECTRONICS
The FM Used
Equipment People.
 Send for New Catalog



WE WANT TO BUY

... your used FM
 General Electric,
 R.C.A. and Motorola
 2-way radios,
 base stations
 and remote units.

CALL US TODAY!



MOTOROLA
D43GGV-3100,
150-170 MHz,

6/12 volt, 30
 watts, front mount
 with "privateline",
 fully narrow band

For use
 on 2 meters.

\$ 88

GENERAL ELECTRIC
MT42, 450-470 MHz,

12 volt, 15 watts, transistor power supply. In 17" case, multi-freq. deck, wide band, less ovens, w/accessories.

\$ 88



GREGORY ELECTRONICS CORP.

239 Rt. 46, Saddle Brook, N. J. 07662
 Phone: (201) 489-9000

TS-520



Kenwood's new go every place ... do everything transceiver.

The TS-520 is the transceiver you have always wanted, but could not buy until now. It is a no compromise 5 band unit for both SSB and CW that performs equally well whether it is at home, in your car, airplane, boat or trailer.

The TS-520 features both a built-in AC power supply and a 12 volt DC power supply plus a built in VOX with adjustable gain, delay and antivoice for complete flexibility.

See Electronics Center for your new Kenwood TS-520. You'll be glad you did.

Electronics Center carries complete lines of Ham equipment, accessories and antennas. Write or call Walt, W5ZYA, or Al, W5PXH for your HAM needs.

electronics center, inc.
2929 N. Haskell • Dallas, TX 75204 • 214/526-2023

Home of the world's largest
Electronic Flea Market
It's free!
First Saturday of each month

GROTH - Type

COUNTS & DISPLAYS YOUR TURNS



- 99.99 Turns
- One Hole Panel Mount
- Handy Logging Area
- Spinner Handle Available

PRICES	POST PAID
TC 2 — \$7.00	
TC 3 — \$7.50	
Spinner (S) — \$1.00	
Add \$0.75 for Air or UPS	

Case: 2x4"; shaft 1/4"x3"
Model TC2: Skirt 2 1/2"; Knob 1 1/2"
Model TC3: Skirt 3"; Knob 2 3/4"

R. H. BAUMAN SALES
P.O. Box 122, Itasca, Ill. 60143

CW FILTER



New Model CWF-2BX—\$19.95.
Ready to use Please include
\$1.00 postage



Model CWF-2—\$12.95. Kit.
\$14.95 Wired, tested, guaranteed.
Please include 55c postage.

- Get Razor Sharp selectivity from any receiver or transceiver.
- Extremely high skirt rejection
- Drastically reduces all background noise.
- No audible ringing.
- No impedance matching.
- Ultra modern active filter design uses IC's for super high performance.

We have what we think is the finest CW filter available anywhere. The 80 Hz selectivity with its steep sided skirts will allow you to pick out one signal and eliminate all other QRM and QRN. Simply plug it into the phone jack or connect it to the speaker terminals of any receiver or transceiver and use headphones, small speaker, or speaker amplifier. Better yet, connect it between any audio stages to take advantage of the built in receiver audio amplifier. Build the 2"x3" CWF-2 PC card into your receiver or get the self contained and ready to use CWF-2BX and plug in!

SPECIFICATIONS

BANDWIDTH: 80 Hz, 110 Hz, 180 Hz. (Switch selectable)
SKIRT REJECTION: At least 60 db down 1 octave from center frequency for 80 Hz bandwidth.
CENTER FREQUENCY: 750 Hz
INSERTION LOSS: None. Typical gain 1.2 at 180 Hz BW, 1.5 at 110 Hz BW, 2.4 at 80 Hz BW.
INDIVIDUAL STAGE Q: 4 (minimizes ringing)
IMPEDANCE LEVELS: No impedance matching required
POWER REQUIRED: CWF-2 6 volts (2 ma.) to 30 volts (8 ma.); CWF-2BX standard 9 volt transistor radio battery
DIMENSIONS: CWF-2 2"x3" PCB board; CWF-2BX 4"x3 1/4"x2 3/16" (black winkle steel top, white aluminum bottom, rubber feet)

TRY this fantastic CW filter. If you don't think it is the best you have ever used, ask for your money back. We will cheerfully refund it. These filters carry a full one year warranty.

Write for FREE brochures and magazine test reports. Other IC active filters available. CW model filter 1 1/2"x2 1/2", low pass, high pass, and wide bandpass filters. Audio amplifiers 1/2", 1, 2 watts. Crystal calibrator.

MFJ ENTERPRISES

P.O. Box 494-A, Mississippi State, MS 39762

VHF/UHF

CONVERTERS PREAMS

Ten meters through 432 MHz. A post card will bring our full 1974 Catalog.



JANEL laboratories

BOX 112, SUCCASUNNA, NJ 07876

Telephone: 201-584 6521

LOOKING FOR A NEW CHALLENGE?

... then build a TV camera!



ONLY SOLID-STATE CAMERA AVAILABLE IN KIT FORM OR FACTORY ASSEMBLED. COMPLETE KIT WITH VIDICON TUBE. ONLY \$166.00. POSTPAID DELIVERY ANYWHERE IN USA, CANADA and MEXICO. OPTIONAL AUDIO SUBCARRIER \$16.95. WRITE or PHONE NOW FOR COMPLETE CATALOG OF KITS, PARTS and PLANS. DIAL 802-967-3771.

1301 BROADWAY N.W. **ATV Research** DAKOTA CITY, NEBR. 68731

CUTTERS **TOOLS** NEEDLE NOSE

New Blemished 4 1/2" To 6" Made By Famous U.S. Manufacturer. Send \$16.00 For 10 Assorted Needle Nose, Cutters or a Mix.

Perfect For P.C. Work

GREENE'S ELECTRONICS

Box 626 St. George, S.C. 29477



RTTY VIDEO DISPLAY UNIT

8000 CHARACTERS - ANY TV SET

VIDITYPE MODEL 872 \$550
WRITE FOR BROCHURE

LELAND ASSOCIATES

18704 GLASTONBURY RD.
DETROIT, MI. 48219

YOUR BEST BET FOR FM!

- PREAMP KITS \$6, WIRED \$10
FREQUENCIES FROM 20 TO 230 MHz
- LED SCANNER KITS \$10
- RECEIVER KITS \$59.95
- FULL STOCK CUSHCRAFT FM ANT.
- COMPONENTS FOR VHF PROJECTS

— SEND SASE FOR LITERATURE —

HAMTRONICS, INC.

182 BELMONT RD. ROCHESTER, N. Y. 14612

COIL WINDING

SPECIALS & STOCK ITEMS

HI Q - LO DC RESISTANCE UNITS
FERRITES - POWDERED IRON - AIR CORE
RF CHOKES - TOROIDS - VARIABLES
HIGH STABILITY POT CORE INDUCTORS

USING MAGNETIC MATERIALS FROM
FERROXCUBE, MICROMETALS, FAIR-RITE,
CAMBION, QUALITY COMPONENTS, ETC.



802-287-4055

Quick Quotes

Send Specs or Sample

CADDELL COIL CORP.

POULTNEY, VERMONT 05764

RADIO & ELECTRONICS CONSTRUCTOR

- Audio Construction Projects
- Receiver Construction Projects
- Transmitter Construction Projects
- Test Equipment Projects
- Radio Control Projects
- . . . and much more

ONE YEAR SUBSCRIPTION — \$7.00
12 MONTHLY ISSUES

Write
RADIO CONSTRUCTOR
Greenville, N. H. 03048



BATTERY BOX

High quality American made. Aluminum battery box. All terminals insulated. Made to hold 2 "C" cells.

50¢ each ppd.

High quality 3" Square Frame PM Speaker, 4 ohm Impedance \$1.25 ea. ppd.

UNUSED PRINTED CIRCUIT BOARD ASSEMBLY. Manufacturers overrun. His loss your gain.



Consists of: 5 - 1/4 Watt resistors, 3 - Silicon Diodes, 2 - Transistors Epoxy, 2 - 1000 Mfd @ 16 Volt Caps, 1 - DPDT 12 Volt Guardian Relay, 1 - SPDT High Current Relay.

Price: \$3.25 ea. ppd.

NEW NEW NEW

GNAT'S EYE LED PILOT LITE. Miniature Led Bulb. Diameter is only .100 inch. Your choice of RED, YELLOW, GREEN. Price is a low 3 for \$1.00 ppd.



Use Standard 7447 Decoder-driver. Seven Segment Read-outs. All tested and guaranteed. Specs included. Fit standard 14 pin DIP socket. Full .335 inch high. Color, RED

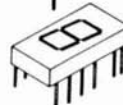

Less Decimal \$2.00 ppd.
With Decimal \$2.25 ppd.
With Colon \$2.50 ppd.

Same unit only contains numeral 1 and plus and minus sign. \$2.25 ppd.

JUST ARRIVED — Transformer, 115 VAC primary, 18 volt, 5 amp ccs or 7 amp intermittent duty secondary \$6.00 ea. ppd.

Transformer — American Made — Fully shielded. 115 V Primary. Sec. — 24-0-24 @ 1 amp with tap at 6.3 volt for pilot light.
Price — A low \$2.90 each ppd.

400 Volt PIV at 25 Amp. Bridge Rectifier.

\$4.00 ea. or 3 for \$10.00 ppd.

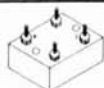

NEW NEW NEW NEW

Factory New Semtech Bridge Rectifiers

ALL 10 AMPS
50 Volt PIV \$1.75 ea.
100 Volt PIV \$2.00 ea.
200 Volt PIV \$2.25 ea.
400 Volt PIV \$2.50 ea.

All Postpaid USA



NEW NEW NEW



3/16 inch Dia. LED Lites
Red \$2.25 ea. ppd.
Green \$4.00 ea. ppd.
Yellow \$4.00 ea. ppd.
Super BI-LED — Lites red with polarity one way and green when you reverse the polarity. Neat for many things.

Price is a Low \$.75 ea. ppd.

SEND STAMP FOR BARGAIN LIST
Pa. residents add 6% State sales tax
ALL ITEMS PPD. USA

m. weinschenker
K 3DPJ BOX 353 · IRWIN, PA. 15642

RADIO EXPO '74

**SEPTEMBER
14 and 15**

**LAKE COUNTY
FAIRGROUNDS**

INTERSECTION ROUTES 45 and 120

GRAYSLAKE, ILLINOIS

HALF-WAY BETWEEN CHICAGO AND MILWAUKEE

MANY DOOR PRIZES —
FULLY ENCLOSED FLEA MARKET —
DISPLAYS BY
MAJOR MANUFACTURERS —
FREE CAMP AREA —
ACRES OF FREE PARKING —
TECHNICAL MOVIES AND SEMINARS
FULL FOOD SERVICES

Convention Headquarters:

**HOLIDAY INN
RTS. 60 & 45
MUNDELEIN, ILL.**

Call your local Holiday Inn
for advance reservations

EXPO TICKETS
BOX 1014
ARLINGTON HTS, ILL.
60006

Gentlemen: Enclosed is
\$..... (check or money
order) in payment for
..... tickets @ \$1.50

Name.....

Address.....

City..... State.....

Zip.....

Make checks payable to Radio Expo
'74. Please enclose S.A.S.E. Offer
expires August 31, 1974.

LET'S CUT OUT THE



- THE ULTIMATE RIG!!
- GOLD PLATED CRYSTALS!!
- AMERICAN MADE!!
- ROCK BOTTOM DEAL!!
- WE'LL BEAT ANY PRICE!!

SOUND TOO GOOD TO BE TRUE?? . . . You see all kinds of claims these days to either have the radio that is best for every one or to offer you the lowest price on earth.

LET'S FACE THE FACTS . . . You are unique and so are your operating conditions. When you call "The FM People" we won't just try and sell you a radio. We will do our best to help you fill your exact FM requirements with the best radio possible in the price range you want.

WHAT IS THE BEST DEAL?? . . . In the long run the lowest price doesn't necessarily mean getting the best deal. Smart buyers look for selection assistance, realistic delivery information, and post sale help along with competitive pricing. This is what you get from "The FM People".

Shop around if you like, but whether you're looking for Motorola or other used equipment; or transceivers by Clegg, ICOM, Genave, Regency and SBE; or accessories to improve your present station . . . give us a call and find out for yourself just why we're called "The FM People".

TERMS OF SALE: Sales to licensed Radio Amateurs for use on Amateur freqs only. All prices FOB Oak Park, IL. Check with order, COD or you can charge to your BankAmericard or Master Charge.

STORE HOURS: Mon.-Thurs. 9:30-6:00, Fri. 9:30-8:00, Sat. 9:30-3:00. Closed Sun. & Holidays
INQUIRIES WITHOUT ZIP CODE OR CALL . . . NO ANSWER

WANTED: Good used FM & test equipment. No quantity too large or small. Finders fees too.



SPECTRONICS INC.

1009 GARFIELD STREET
OAK PARK, ILL. 60304
(312) 848-6778



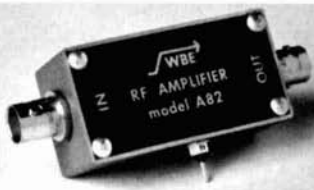

Flat 20 dB gain over entire bandwidth; 5 dB NF; 1 V max output; Specify 50 or 75 ohms; Rugged cast alum case; +20 VDC @ 25 mA bias; Models A82 & A82A 1-500 MHz, high precision, flat ± 2 dB; Model A82H 4-450 MHz, economy version, flat ± 1.5 dB; Size: A82 2 1/4" x 1 3/8" x 7/8", A82A & A82H 2 1/4" x 1 3/8" x 7/8"; Price: A82 \$105.00, A82A \$97.00, A82H \$45.00.

These preamplifiers are ideal for use with frequency counters & meters, signal & harmonic generators, detectors, single & multiple HF & VHF receivers, sweep gear, and wide bandwidth applications.

Other WBE, INC. products covering 1-500 MHz include: signal & power directional couplers, hybrid splitters & combiners, impedance (return loss) bridges, 50/75 ohm transformers, comparators, & filters.

(see QST Review, May 1973, pg. 41)

Call or Write for Complete Catalog & Data (602) 254-1570

WIDE BAND ENGINEERING COMPANY, INC.

P.O. Box 21652H, Phoenix, AZ 85036

3-D MAGNETIC CALL SIGNS

3 inch letters

Your choice of colors —
Black, Red, Blue or Green

Adherence to metallic surfaces test up to 180 MPH

\$4.00 each — 2 for \$7.00 (same call)

ALSO

RUBBER STAMPS

Made to order — 3 lines - \$4.00

Preinked stamp pad \$1.35

(Please print or type all copy)

WB80TV SPECIALTY PRODUCTS

P. O. Box 187 • Grasslake, Michigan 49240

DIGITAL:THEORY,DESIGN,
CONSTRUCTION

LOGIC NEWSLETTER[©]

SAMPLE COPY \$ 1.00
LOGIC NEWSLETTER
POB 252
WALDWICK,N.J. 07463

The DELA-BRIDGE I

Analyzes antenna characteristics, simplifies adjustment.

The DELA-BRIDGE I, when tied into your grid dip meter or low power exciter, quickly and easily analyzes: (1) Existing antenna & feed line characteristics, (2) Tuning & loading coils, (3) Filter & interstage coupling networks. Direct readout then lets you adjust for optimum performance.

DELA-BRIDGE I Specifications:

FREQUENCY RANGE: 50 KHz to 250 Mhz

RESISTANCE RANGE: 0 to 500 Ohms, balanced or unbalanced, log scale

SIGNAL REQUIREMENTS: 1 MW to 2 Watts maximum from any grid dipper or signal generator

POWER REQUIREMENTS: Internal 9V battery

ACCURACY: $\pm 3\%$ at 50 Ohms

TO READ & INTERPRET: Complete null and reactance determination—not frequency sensitive—internal integrated circuit amplifier allows use with low signal inputs



DELA-BRIDGE I guaranteed for 1 year by Delavan Electronics, Inc.*

Delavan Electronics' new Amateur Products Group might be a new name to you, but we're no stranger to amateur radio operations and equipment. Delavan is well funded and deeply involved in aerospace and industrial controls. Delavan stands behind its products 100% and guarantees the DELA-BRIDGE I unconditionally for 1 full year.

Order your DELA-BRIDGE I today!

Gentlemen

Please send me one DELA-BRIDGE I @ \$39.95, completely assembled & tested

Please send me one DELA-BRIDGE I ready to assemble Kit @ \$29.95

Arizona residents add 4% sales tax. Out-of-state residents add \$2.50 to cover handling and airmail postage.

DELAVAN ELECTRONICS, INC. AMATEUR PRODUCTS GROUP

14441 North 73rd Street • Scottsdale, Arizona 85260 • (602)948-6350
*Dunn's Number 05-689-6756

IT ONLY HAPPENS ONCE IN A LIFETIME!



NORELCO VIDEO TAPE RECORDER-PLAYBACKS

- WEIGHS ONLY 26 POUNDS
- LONG LIFE FERRITE HEADS
- EXTREMELY QUIET
- USES INEXPENSIVE 1/2" TAPE
- HORIZ RESPONSE 2 1/2 MHz
- OPERATES FROM 110 VOLT AC
- SOME MODIFIED WITH LIGHT TO INDICATE UNIT IN USE
- STANDARD AUDIO-VISUAL SIGNALS
- 1 HOUR ON 2400 FOOT TAPE

BRAND NEW, AS IS \$399.00

ALSO, SHIBADEN FP-707 VIDICON CAMERA WITH CRT VIEWFINDER AND 5-1 ZOOM LENS.

12 VOLT DC MODEL \$329.00

AC MODEL \$399.00

tape YOUR FAVORITE TV
SHOWS.



build AN INEXPENSIVE
LIBRARY OF THE TV
SHOWS YOU LIKE BEST.

7" Reel 2400' 1/2" VIDEO TAPE IN BOX. New American Made \$15.00 each. Minimum Order 5. Limited Quantity.

HUNDREDS OF ADDITIONAL VIDEO ITEMS, WRITE FOR VIDEO CATALOG.

M-TECH The Quality 2 Meter FM Amplifier

- Rated for continuous service
- VSWR Protected For Any Load (0-oo ohms)
- Reverse Current Protection
- Micro-Strip Inductors For Stability

P15A1
1-3 Watts In
12-20 Watts Out
\$55

P50A10
2-18 Watts In
14-60 Watts Out
\$98

P100A10
2-12 Watts In
40-110 Watts Out
\$198

P100A20
18-25 Watts In
90-120 Watts Out
\$145

M-TECH Amplifiers Are in Stock At Communications Unlimited.

COMMUNICATIONS UNLIMITED

9519 MAIN STREET P.O. BOX 463
WHITMORE LAKE, MICHIGAN 48189

Store hours, noon to 6PM, Monday thru Saturday. (313-449-4367)

for the EXPERIMENTER!

INTERNATIONAL EX CRYSTAL & EX KITS
 OSCILLATOR • RF MIXER • RF AMPLIFIER • POWER AMPLIFIER



1. MXX-1 TRANSISTOR RF MIXER

A single tuned circuit intended for signal conversion in the 3 to 170 MHz range. Harmonics of the OX oscillator are used for injection in the 60 to 170 MHz range. Lo Kit 3 to 20 MHz, Hi Kit 20 to 170 MHz (Specify when ordering).....**\$3.50**



2. SAX-1 TRANSISTOR RF AMP

A small signal amplifier to drive MXX-1 mixer. Single tuned input and link output. Lo Kit 3 to 20 MHz, Hi Kit 20 to 170 MHz (Specify when ordering).....**\$3.50**



3. PAX-1 TRANSISTOR RF POWER AMP

A single tuned output amplifier designed to follow the OX oscillator. Outputs up to 200 mw, depending on the frequency and voltage. Amplifier can be amplitude modulated. Frequency 3,000 to 30,000 KHz.....**\$3.75**

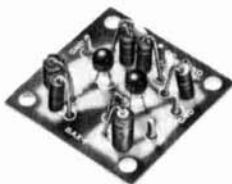

4. BAX-1 BROADBAND AMP

General purpose unit which may be used as a tuned or untuned amplifier in RF and audio applications 20 Hz to 150 MHz. Provides 6 to 30 db gain. Ideal for SWL. Experimenter or Amateur**\$3.75**



5. OX OSCILLATOR

Crystal controlled transistor type. Lo Kit 3,000 to 19,999 KHz, Hi Kit 20,000 to 60,000 KHz. (Specify when ordering).....**\$2.95**



6. TYPE EX CRYSTAL

Available from 3,000 to 60,000 KHz. Supplied only in HC 6/U holder. Calibration is $\pm .02\%$ when operated in International OX circuit or its equivalent. (Specify frequency)**\$3.95**

for the COMMERCIAL user...

INTERNATIONAL PRECISION RADIO CRYSTALS

International Crystals are available from 70 KHz to 160 MHz in a wide variety of holders. Crystals for use in military equipment can be supplied to meet specifications MIL-C-3098E.

CRYSTAL TYPES: (GP) for "General Purpose" applications
 (CS) for "Commercial Standard"
 (HA) for "High Accuracy" close temperature tolerance requirements.



write for
CATALOG



CRYSTAL MFG. CO., INC.
 10 NO. LEE • OKLA. CITY, OKLA. 73102

SWAN

EAST COAST SERVICE CENTER

We also service all other popular makes.

Complete professionally staffed laboratory fully equipped for all aspects of maintenance and service. Graduate Engineer on duty. Custom Design services available.

PROFESSIONAL ELECTRONICS CO., INC.

1710 JOAN AVE. EUDWOOD BRANCH
BALTIMORE, MD. 21204
301-661-2123

Webster
radio



FT101B Yaesu
\$649.00

2602h E. Ashlan
Fresno, Calif. 93726

Phone (209) 224-5111

THE ULTRA-BAL 2000

- NOW An extremely rugged, weather-proof BALUN!
- Full 2KW, 3-30 MHZ., 1:1 or 1:4 ratios.
 - Special Teflon insulation. May be used with tuned lines and tuners.
 - With dipole insulator and hang-up hook.

ONLY \$9.95ppd. (state ratio)

At your dealer or order direct

K.E. Electronics Box 1279, Tustin Calif. 92680

**LOW PRICES
ON POPULAR COMPONENTS**

IF FILTERS

- Monolithic crystal filters at 10.7 and 16.9 MHz
- Ceramic filters at 455 kHz

SEMICONDUCTORS

- VHF power transistors by CTC-Varian
- J and MOS FETS
- Linear ICs — AM/FM IF, Audio PA
- Bipolar — RF and AF popular types

INDUCTORS

- Molded chokes
- Coil forms — with adjustable cores

CAPACITORS

- Popular variable types

QUALITY COMPONENTS

- No seconds or surplus
- Name brands — fully guaranteed
- Spec sheets on request

GREAT PRICES

- Price breaks at low quantities
- Prices below large mail-order houses

WRITE FOR CATALOG 173

AMTECH, INC.

P. O. BOX 624, MARION, IOWA 52302
(319) 377-7927 or (319) 377-2638

**Now is the time for all good hams
to come to the aid of their code.**



With the HAL MKB-1, you can send perfect CW as easily as using a typewriter. The all solid-state MKB-1 is a complete Morse keyboard codetypewriter, with code speed variable from 10 — 60 WPM. Dot-to-space (weight) ratio is also variable.

The MKB-1 is full of features, like a variable volume/tone oscillator with internal speaker. Plus its own power supply. Computer-grade key switches. And it drives cathode or grid-block keyed transmitters.

An available option is the HAL KB-ID automatic identifier. Touch a button and "DE," followed by your call is automatically transmitted. And you can add two 2-letter characters of your own, e.g., "73 OM."

Assembled, the MKB-1 costs \$250; with the KB-ID option, add \$40. (We'll program your call into the

KB-ID for you.) The MKB-1 kit is \$170; with the KB-ID kit, add \$29. Come to the aid of your code today — and enjoy CW like never before.

HAL HAL Communications Corp.
Box 365, Urbana, Illinois 61801
Telephone: (217) 359-7373

Enclosed is \$ _____ (MKB-1)
\$ _____ (KB-ID option)

Call letters _____

Charge to my Master Charge # _____

Charge to my BankAmericard # _____

M/C Interbank # _____

Card exp. date _____

Please send me the HAL catalog.

Name _____

Address _____

City/State/Zip _____

All prices include U.S.A. shipping. Add \$5 for air shipment. Ill. res. add 5% sales tax.



HI THERE !!!
MEET THE AMAZING NEW

SABA-5 PREAMPLIFIER

WB4TPI (Jerry) Says " ' / # @ ? ,
does that thing work! "

WA4ILS (Hugh) Says " Couldn't have made
weak station contacts without it. "

W4VE (Frank) Says " Will enhance any
station's capabilities. "

W4FPC (Mac) Says " Well worth while. "

Note Above evaluations on Collins 75A4,
S-Line, Drake R4-B, R4-C Signal-One,
FPM 300

Mfg. by,



SYMTEK Inc.
P.O. BOX 128
CLEARWATER, FLA.
33517

Specifications

- Solid State Circuitry MOS-FET
- 80-40-20-15-10 Meters *NO TUNING*
- Ultra Low Noise-High Useful Gain
- Gain: 20 db min. Typical 25 db
- Noise Figure: Less than 2.5 db
- High Quality Communications Design
- Broadband with adequate MARS Overlap
- Minutes to install on Receivers
- Battery or External Power Operation
- No Strong Signal Overloading
- Allows reduced RF Gain on receiver for improved cross modulation
- Attractive Black textured and gray Cabinet 3X4X5
- Low Current drain (Appr. 15ma @ 18V)
- LED Indicator light

THRU YOUR FAVORITE DISTRIBUTOR

PRINTED CIRCUIT BOARDS

for any amateur project in any
amateur periodical.

Published with artwork

Get your homebrew projects off to
a professional start

Write for Complete Details and Prices

D. L. "Mac" McClaren, W8URX

Printed Circuit Service for the Amateur

19721 Maplewood Ave. Cleveland, Ohio 44135
216-267-3263

FM Schematic Digest

A COLLECTION OF
MOTOROLA SCHEMATICS

Alignment, Crystal, and Technical Notes
covering 1947-1960

136 pages 11 1/2" x 17" ppd \$7.50

S. Wolf

P. O. Box 535

Lexington, Massachusetts 02173

NASEM

HAM/HOBBY/EXPERIMENTER GRADE
SEMICONDUCTORS

COMMUNICATIONS INTEGRATED CIRCUITS

IC Type	Description	Case	Price, Ea.
NA555	Versatile Timer	8-DIP	0.99
NA555-2	Dual Timer	16-DIP	1.55
NA370	AGC/Squelch/VOX	10-T05	1.20
NA371	Versatile RF/IF	10-T05	1.29
NA3018	4-Trans. Array	12-T05	0.89
NA3026	Dual Diff. Array	12-T05	0.99
NA3086	5-Trans. Array	14-DIP	0.45
NA3039	Diode Array	10-T05	0.75
NA3036	Dual Darlingtion	10-T05	0.75
NA1595	Analog Multiplier	14-DIP	1.90
NA8038	VCO/Sine/Sq./Tri.	14-DIP	4.50
NA1596	Bal. Mixer/Mod.	10-T05	1.20

COD-PHONE

(408) 867-5900

AUTOMATIC RECORDER 24 HOUR COD TELEPHONE ORDER SERVICE

Order may not be shipped without full information. Before calling jot down and be ready to clearly dictate:

1. Name & Full Street Address (NO P. O. Boxes) Include ZIP
2. Your telephone number, including area code.
3. Your Order - Type, Price, Quantity.

U.S. Destinations only for COD. Requested return calls collect only. See TERMS for added COD charges.

"HOBBYIST-EXPERIMENTER" EQUIV. TRANSISTORS

Type	Description	Case	Price, Ea.
HNP50	PNP RF 250MHz	TO18	0.49
HNP52	PNP RF 200MHz	TO18	0.59
HNP55	PNP RF 200MHz	TO92	0.59
HNP715	PNP GP RF/AUDIO	TO92	0.59
HNP716	PNP MED. CURR. SW.	TO92	0.59
HNP724	PNP GP AUDIO	TO92	0.49
HNP736	PNP GP AUDIO	TO92	0.59

SPECIAL! MICROTRANSMITTERS!

NA2000	100mw AM on 10 Meters	9.95
NA2001	250mw AM on 10 Meters in stud mount package	14.95

Both types usable at reduced output at 6 Meters and above. Requires external crystal and 2 tuned circuits. With Data/applications.

TERMS:

Prepaid U.S. orders over \$10.00, we pay shipping.
Prepaid U.S. orders under \$10.00, add \$1.00 chg.
Prepaid Foreign orders over \$10.00, add postage.
Prepaid Foreign orders under \$10.00, add \$1.00 plus postage.
COD U.S. orders over \$10.00, add \$1.50 chg.
COD U.S. orders under \$10.00, add \$2.50 chg.
No Foreign COD orders.
California residents add 6% sales tax.
Confused? Please read again before ordering.

NASEM, Box A1, Cupertino, Ca. 95014



Simply The Best...



ICOM

*3-8 Kamikuratsukuri-cho, Higashi Sumiyoshi-ku,
Osaka, Japan.*

Proudly Distributed Warranted and Serviced

ICOM WEST INC.
Suite 232—Bldg.II
300·120th Avenue N.E.
Bellevue, Washington, 98005
(206)454-2470

By

ICOM EAST Div ACS Inc.
Suite 501
13777 N. Central Expwy.
Dallas, Texas, 75231
(214)235-0479



CRYSTAL FILTERS and DISCRIMINATORS

1 27/64" x 1 3/64" x 3/4"



by
K.V.G.

9.0 MHz FILTERS

XF9-A	2.5 kHz	SSB TX	\$31.95
XF9-B	2.4 kHz	SSB RX	\$45.45
XF9-C	3.75 kHz	AM	\$48.95
XF9-D	5.0 kHz	AM	\$48.95
XF9-E	12.0 kHz	NBFM	\$48.95
XF9-M	0.5 kHz	CW	\$34.25

9.0 MHz DISCRIMINATORS

XD9-01	± 5 kHz	RTTY	\$24.10
XD9-02	± 10 kHz	NBFM	\$24.10
XD9-03	± 12 kHz	NBFM	\$24.10

9 MHz CRYSTALS (Hc25/u)

XF900	9000.0 kHz	Carrier	\$3.80
XF901	8998.5 kHz	USB	\$3.80
XF902	±001.5 kHz	LSB	\$3.80
XF903	8999.0 kHz	BFO	\$3.80
F-05	Hc25/u Socket		.50

(Export Inquiries Invited)

VHF CONVERTERS UHF

	MMc 50	MMc 144	MMc 220	MMc 432	MMc 1296
RF Freq. (MHz) †	50-54	144-148	220-224	432-436	1296-1300
IF Freq. †	28-32	28-32	28-32	28-32	144-148
N.F. (typical)	2.5dB	2.8dB	3.4dB	3.8dB	9.0dB
Nom. Gain	30dB	30 dB	26dB	28dB	9.0dB
	\$53.70	\$53.70	\$64.45	\$64.45	\$85.95

Power 12V D. C.

1 1/4" x 2 3/8" x 4 3/8" + connectors

Very low N. F. units on special order.

†Other ranges, amateur & commercial, to order.

Shipping: Filters, \$.50; Converters, \$1.00



**SPECTRUM
INTERNATIONAL**
BOX 1084 CONCORD
MASSACHUSETTS 01742

— PCB KITS —

RTTY SPEED CONVERTER/Drilled PCB 5 & 11 VDC	\$42.00
DRILLED PCB ONLY	\$ 6.50
RTTY AFSK Gen. All Shifts & CW I.C. 9 VDC @ 2ma	\$7.25
100 kHz XTAL CALIBRATOR Less Xtal 9 VDC @ 2ma	\$5.25
POWER SUPPLY — 28 VDC @ 650 ma output	\$9.85
PREAMP MICROPHONE 26 dB Gain 9 VDC @ 1ma	\$3.85
LIMITER PREAMP For High Z Mike 9 VDC @ 1ma	\$5.30
PRODUCT DETECTOR For Your Receiver 9 VDC @ 1ma	\$3.95
"S" METER KIT Less 1ma Meter 6.3VAC	\$5.25
SWR METER, Stripline, Less 200µa Meter	\$3.25
WVW CONVERTER 3.5-4.0 MHz Output 9 VDC @ 5ma	\$5.75
Requires 6-6.5MHz Crystal	
6 METER CONVERTER FET Front End 9 VDC @ 5ma	\$6.50
7-11 MHz Output, Less 43 MHz Xtal	
CW KEYING MONITOR, RF Keyed, Less Spkr. 9 VDC @ 9ma	\$5.20
POWER SUPPLY - 9 VDC @ 50ma Output 115VAC	\$5.35
6 METER CASCODE PREAMP 80 VDC @ 4.5ma	\$5.45
Wired & Tested Less 2 ea 6CW4 Nuvistors	
DRILLS, #54, 56, 58 or 60 (each) \$5.50	
Finest Quality for PCB's, Made in USA Three For \$1.25	

EXCEPT AS NOTED ABOVE, ALL KITS ARE NEW, 100% SOLID STATE, AND COME COMPLETE WITH AN UNDRILLED G-10 PCB (PRINTED CIRCUIT BOARD) AND ALL PCB MOUNTED COMPONENTS. KITS ARE LESS POWER SUPPLIES, CHASSIS, AND ENCLOSURE HARDWARE. SEND SELF-ADDRESSED, STAMPED ENVELOPE FOR COMPLETE DATA SHEET AND SCHEMATIC.

SATISFACTION GUARANTEED. RETURN IN 30 DAYS FOR REFUND. ALL KITS POSTPAID. INCLUDE 50¢ HANDLING CHARGE. WASHINGTON RESIDENTS ADD 5.3% SALES TAX.

Martex Corporation

519 S. AUSTIN, SEATTLE, WASH. 98108

NEW FOR 74

ECM 5A FM Modulation Meter

- Operates 30-500 MHz
- Crystal controlled for fast and easy operation
- Peak reading
- Accurate within 1 kHz at 15 kHz

Only \$85.00 less batteries and crystal



Phone or write "Skin" W9HAK for complete information Dial 812 476 2121



Available by direct mail only. ORDER INFO: Send check or money order for \$85.00 plus \$1.50 for handling. Indiana residents add 4% sales tax. Crystals for 146.94 MHz \$3.95 ea. All other freqs: \$7.10

ECM

ECM Corporation
412 N. Weinbach Ave.
Evansville, Indiana 47711

C F P ENTERPRISES

866 RIDGE ROAD, LANSING, N. Y. 14882

Central Upstate New York's
Mail-Order Headquarters

JIM BECKETT, WA2KTJ has joined us as a sales and service representative.

We can now offer limited service on equipment that we sell.

Office & Salesroom Hours by Appointment Only

24-Hour Phone: 607-533-4297

Send SASE for Monthly Listing of Used Equipment and Bargain Goodies

Trade-ins accepted on both new and used equipment. Cash deals get prepaid shipping in the Continental U.S.A. plus a 15% discount on used items on our regular listing!!!!

Wilson Electronics

DIRECT

SPECIAL SUMMER SALE !!!

WILSON 1402SM HAND HELD 2.3 WATT FM TRANSCEIVER

- * Rubber Flex Antenna
- * Complete Set NiCad Batteries
- * Leather Case
- * Three Sets of Crystals

16/76, 34/94, 94/94, Other Available at \$8.00 Pr.

ALL FOR JUST \$199⁹⁵

- 6 Channel Operation, Individual Trimmers On All TX and TR Xtals. All Xtals Plug In.
- S Meter Battery Indicator.
- 10.7 IF and 455 KC IF Ceramic Filter.
- .3 Microvolt Sensitivity For 20dB QT.
- 2.3 Watts Minimum Output.
- Microswitch Mike Button.
- Size 8-7/8 x 1-7/8 x 2-7/8 Inches.
- Weight 1 lb. 4 ounces, Less Battery.
- Current Drain Rx 14MA TX 380 MA.

ACCESSORIES:

SMI Speaker Mike \$24.00

BCI Battery Charger \$29.95

1410A Amplifier Mobile Mount \$99.00



To: Wilson Electronics
P.O. Box 794
Henderson, Nevada 89015
(702) 451-5791

Ship me 1402 SM Special Summer Package
Plus SM1 1410A BC1

Enclosed is \$ _____ Check Money Order

Master Charge Bank Americard
_____ M/C Interbank # _____

Card Expiration Date _____

Extra Xtals _____

Name _____

Address _____

City and State _____ Zip _____

All orders will be shipped Air Mail within 24 hours after receipt of order (excluding weekends). Enclose additional \$3.00 for prepaid Air Mail shipping. Nevada residents add sales tax.
Sale ends October 31, 1974

MIDLAND INVITES YOU TO R.S.V.P.

Beginning with this announcement, every Midland 2-meter mobile transceiver sold will have R.S.V.P. Not an extra feature or secret ingredient, but a real benefit for every repeater user. What's R.S.V.P.? Ask your Midland dealer today.



ABOVE: Midland 15-watt, 12-channel 2-meter mobile transceiver with crystals for .16/.76, .34/.94, .94/.94

BELOW: Midland 30-watt, 12-channel mobile with dual channel selectors, crystals for .16/.76, .34/.94, .94/.94

For Free Midland Amateur Catalog, write Dept. H. P.O. Box 19032, Kansas City, Mo. 64141

MIDLAND ELECTRONICS COMPANY

ALL-BAND ANTENNA CONNECTOR



HYE-QUE 1 molded connector has eyelets for securing antenna elements, heavy copper leads, coax PL259 connector for feedline, and tie-point for antenna support. Drip-cap protects connector. Reinforced. At your dealer's, or \$3.95 postpd. Companion insulators, 2 for 99¢ ppd. Instructions included.

BUDWIG MFG. CO., P.O. Box 97H, Ramona, Calif. 92065

"THE ELECTRONICS STORE"
RMS CORPORATION
 675A GREAT ROAD (ROUTE 119)
 LITTLETON, MASS. 01460

7400 SERIES I.C.'s	MATRIC-KEYERS
HUSTLER ANT.	APOLLO CABINETS
VHF ENG. KITS	VENUS SSTV

LARGE INVENTORY OF COMPONENTS
 I-495 to Rte. 119, Groton Exit 40
 2 Miles On The Right

NEW HOT SUGGESTED GIFT ITEM

DIGITAL CLOCK KIT
 \$34.95

Full 6 digit LED display
 Complete with anodized alum. case. All parts and P.C. board. With complete assembly drawings. Ship wt. 1 1/2 lbs.

SLA-1 7 SEG READOUT \$2.25 EA. 6/\$12.50
12 ASS'T'D LEDS, RED, GREEN, AMBER, MOSTLY JUMBO 12 FOR \$2.50

Orders over \$10.00 ppd. Others add 50¢ handling & mailing.

HAL-TRONIX
 P. O. BOX 1101 SOUTHGATE, MICH. 48195
 (313) 285-1782

**For
FREQ.
STABILITY**

Depend on JAN Crystals. Our large stock of quartz crystal materials and components assures Fast Delivery from us.

CRYSTAL SPECIALS

2-METER FM for most Transceivers ea. \$3.75
 144-148 MHz — .0025 Tol.

Frequency Standards	
100 KHz (HC 13/U)	4.50
1000 KHz (HC 6/U)	4.50
Almost all CB Sets, Tr. or Rec. (CB Synthesizer Crystal on request)	2.50
Any Amateur Band in FT-243 (80-meter, \$3.00 - 160-meter not avail.) 4 for 5.00	1.50

For 1st class mail, add 20¢ per crystal. For Airmail, add 25¢. Send check or money order. No dealers, please.

**JAN
CRYSTALS**

Division of Bob Whan & Son Electronics, Inc.
 2400 Crystal Drive
 Ft. Myers, Florida 33901

All Phones
 (813) 936-2397

Send 10¢ for new catalog with 12 oscillator circuits and lists of frequencies in stock.



**A SPECIAL SUMMER
OFFER FROM ROBOT:**

FREE PERSONALIZED SSTV TAPE RECORDING*

**with the purchase of the Robot 70A
Slow Scan Monitor.**

This personalized tape with your call, handle, QSL art, etc., and the Robot Monitor are all you need to operate two way SSTV. Simply play the tape on your audio tape recorder plugged into the mic jack of your transmitter and you are transmitting an SSTV video signal. With this special summer offer you can operate two way SSTV for just \$295, the price of the monitor alone.

And there's plenty of SSTV action! Thousands of amateur operators are now operating SSTV in

the U.S. alone with all 50 states represented, and more than 80 countries have been logged on two way SSTV. And with our special offer, you can join the fastest growing amateur radio activity for just \$295.

But this is a limited offer* so act today. With your Robot Model 70A Slow Scan Monitor order, let our girl Suzie know what you want on your SSTV tape (cassette or reel), and send a photo or art work if you want these included. Your order, with your FREE personalized SSTV tape will be on its way to you within a few days.



**ORDER FACTORY
DIRECT
TODAY**

ROBOT

ROBOT RESEARCH, INC.
7591 Convoy Court
San Diego, California 92111
Phone 714-279-9430

**Offer good until August 31, 1974, and limited to USA and Canada.*

ROBOT SSTV'ers; please send us your QSL card to brighten our office and convention displays.

NATIONAL BUY ANY 3 — TAKE 10% LINEAR OP AMPS

LM-300	POS V.R. (super 723) TO-5	\$.91
LM-301	Hi-performance op amp (A)	.41
LM-302	Voltage follower TO-5	.91
LM-305	5V voltage Reg. TO-5	1.19
LM-307	Super 741 op amp (A)	1.19
LM-308	Hi-Q fet type op amp TO-5	1.19
LM-309H	SV Volt-Regulator TO-5	1.19
LM-309K	SV Volt-Reg. 1 Amp TO-3	1.85
LM-310	AM-FM SSB I.V. Dip	3.50
LM-311	Hi-perf. Volt. Comp. (A)	1.19
LM-319	Hi-speed Dual Comp. DIP	1.50
LM-320	MINUS 5, 12 or 24V V.R. TO-3	1.50
LM-339	Quad Comparator, DIP	2.50
LM-324	Quad (4-741) Dip	2.45
LM-350	Dual peripheral driver	.41
LM-370	AGC Saseuch on amp. TO-5	1.19
LM-373	AM-FM SSB I.A.D. TO-5	3.50
LM-374	AM-FM SSB I.V. Dip	3.50
LM-377	Dual 2-watt audio amp	3.00
LM-380	2-watt audio amplifier TO-5	1.69
LM-381	Low noise dual pre amp DIP	1.95
LM-382	Low noise dual pre amp DIP	1.95
LM-703	RF-IF amp. TO-5	.56
LM-709	Operational amplifier (A)	.36
LM-710	Differential amplifier (A)	.45
LM-712	Dual Diff. Amp (A)	.95
LM-723	Voltage Regulator (A)	.89
LM-725	Instrument Op Amp	.95
LM-733	Differential Video	1.75
LM-734	Freq. Comp. 741 (A)	.41
LM-741CV	Mini 741C	.41
LM-747	Dual 741 (A)	.89
LM-748	Freq. adjustable 741C (A)	.44
LM-1303	Stereo pre amp DIP	.95
LM-1304	AM-FM Stereo Exp.	1.35
LM-1307	FM Multi. Stereo Dem. OTP	1.35
LM-3028	Differential RF/IF amp	1.50
LM-3900	Quad "current mirror" amp	.95
LM-4250G	Programmable op amp	2.50
LM-75451	Dual peripheral driver	.45
LM-75453	Dual peripheral driver	.45
LM-75492	Hex digit driver, 250ma, DIP 1.85	

(A) TO-5, Dip or mini Dip
1,000,000-PC INVENTORY

LINEAR Op Amps

531	Hi slew rate op amp (TO-5)	\$2.50
532	Micro power 741 (TO-5)	2.50
533	Micro power 709 (TO-5)	2.50
534	Hi slew rate op amp (TO-5)	2.50
550	Precision 723 voltage reg. (DIP)	1.17
555	Timer 2 u Seconds to 1-hr. (A)	1.25
556	5 Times faster than 741C	2.10
560	Phase lock loops (DIP)	2.95
561	Phase lock loops (DIP)	2.95
562	Phase lock loops (DIP)	2.95
563	Phase lock loops (A)	2.95
565	Function generator (TO-5)	2.95

567	Tone decoder (A)	2.95
703C	Hi-grain DC amp (TO-5)	1.50
704	Volt diff. (A)	1.50
711C	Dual diff. comp. (A)	.33
723C	Voltage regulator (A)	.69
741CV	Freq. comp 709 (Mini DIP)	.44
743C	Freq. adj. 741C (A)	.44
753	Gain Block	1.75
739-739	Dual stereo preamp	1.98
741-741	Dual 741C TO-5	.89
PA285	5-Watt voltage regulator	1.00
ULN2300M	Op amp with SCR	1.00
CA3065	Video Audio system	1.00
CA3195	Dual 15V Tracking V.R.	2.50
4136	Quad 741's (DIP)	1.95
RC-285	Dual 555's	2.95

(A) TO-5 or DIP Buy any 3 — Take 10%

WRIST WATCH LIQUID CRYSTAL DISPLAY

*3-1/2 digit, 7 segment *Only 1-1/16 x 11/16 x 1/4"

See POPULAR ELECTRONICS (Jan., 1974) for building your own electronic digital wristwatch using the Liquid Crystal Display (LCD) as its basis. Easy to see, 1/4" digit display, requires less than 1/1000 of power as LED's. Visibility increases with ambient light. Difficult to read in light. Includes SECONDS in center of display. NO NEED OF TRANSISTOR-RESISTOR interface, as LED's, thus smaller package. Chip contains holder, tiny connecting terminals, and "slide-in-place" chrome spring face plate. Size of display in holder: 1-1/16" x 11/16" x 1/4". Operating from 1.5V hearing aid cell. Uses the new and latest CMOS micro-circuitry. We include copy of write up from PE magazine.

Only **\$19.95**

HIGH POWER TRANSISTOR WITH HEAT SINK

*\$1.49 for \$3

Removed from new equipment! Includes popular 2N174 doorknob transistor TO-36, germanium PNP, 150 watts, Vce 80V, 15 amps, 10 hfe. For ignition, high power transmitters, etc. Mounted on heat sink \$ 2.95 + \$1.49.

"THE PRO" — HI-Q DYNAMIC PENCIL MIKE

Only **\$6.95**

Sold elsewhere for over \$10. All metal construction with stand, 6-ft. cord, and standard mike plug. By General Electric. NO IMPORT! Highly polished with chrome trim. *Over-engineered, 20,000 ohm input, 60 to 100kHz freq. resp.* Crisp, ultra-sensitive, high quality, hi-fidelity. Ideal for PA, CB, and all HiAM equipment. May be hand-held, too! Mike "long 1/2" dia., with taper. Heavy-duty grey metal stand, 2 1/2 x 2 1/4 x 1 1/2". Ideal for our full stereo Amp. wt., 1-lb.

Inflation-Fighting ECONOMY IC PRICES

Buy 100 — Take 20%

Type	Sale	SN7432	.55	SN7471	.55	SN74108	.95	SN74180	1.95
SN7400	\$0.30	SN7437	.55	SN7472	.55	SN74112	.95	SN74181	1.75
SN7401	.30	SN7438	.55	SN7473	.55	SN74113	.95	SN74182	1.95
SN7402	.30	SN7440	.30	SN7474	.55	SN74114	.95	SN74183	1.95
SN7403	.30	SN7441	1.40	SN7475	1.05	SN74121	.60	SN74184	2.00
SN7404	.35	SN7442	1.50	SN7476	1.05	SN74122	.95	SN74185	2.00
SN7405	.35	SN7443	1.50	SN7477	1.05	SN74123	1.20	SN74186	2.50
SN7406	.35	SN7444	1.50	SN7478	.95	SN74125	.71	SN74187	2.00
SN7407	.35	SN7445	1.50	SN7479	1.05	SN74126	.71	SN74188	2.50
SN7408	.35	SN7446	1.65	SN7480	1.25	SN74140	1.25	SN74189	2.50
SN7410	.30	SN7447	1.50	SN7481	1.25	SN74141	1.25	SN74190	2.50
SN7411	.35	SN7448	1.50	SN7482	1.25	SN74142	1.25	SN74191	2.50
SN7413	.95	SN7450	.30	SN7483	1.25	SN74143	1.25	SN74192	2.50
SN7416	.35	SN7451	.30	SN7484	1.25	SN74144	1.25	SN74193	2.50
SN7420	.30	SN7452	.30	SN7485	1.25	SN74145	1.55	SN74194	2.50
SN7421	.35	SN7453	.55	SN7486	1.55	SN74146	1.55	SN74195	2.50
SN7422	.35	SN7454	.55	SN7487	1.55	SN74147	1.55	SN74196	2.50
SN7423	.35	SN7455	.55	SN7488	1.55	SN74148	1.55	SN74197	2.50
SN7425	.50	SN7456	.30	SN7489	1.55	SN74149	1.55	SN74198	2.50
SN7426	.50	SN7457	.30	SN7490	1.49	SN74150	1.55	SN74199	2.50
SN7430	.30	SN7458	.30	SN7491	1.49	SN74151	1.55	SN74200	2.50
		SN7459	.30	SN7492	1.35	SN74152	1.55		
		SN7460	.30	SN7493	1.35	SN74153	1.55		
		SN7461	.30	SN7494	1.35	SN74154	1.55		
		SN7462	.30	SN7495	1.35	SN74155	1.55		
		SN7463	.30	SN7496	1.35	SN74156	1.55		
		SN7464	.30	SN7497	1.35	SN74157	1.55		
		SN7465	.30	SN7498	1.35	SN74158	1.55		
				SN74100	1.65				
				SN74107	.75				

7-SEGMENT LED Readouts

(All "LED" TYPES)

Type	Char.	Each	Special
MAN-1	.27	\$3.75	3 for \$9.
MAN-3	.12	1.49	3 for \$5.
MAN-4	.19	2.50	3 for \$3.

REFLECTIVE BAR TYPES

707	.33	2.50	3 for \$6.
704	.33	2.50	3 for \$6.
SLA-1**	.33	2.10	3 for \$5.
SLA-2**	.70	4.95	3 for \$13.
SLA-11**	.33	2.50	3 for \$10.
SLA-21**	.33	3.95	3 for \$10.

*By Litronix. **By Opco, equal to MAN-1 or MAN-4 specs. Color - RED. †Green, ††yellow

LED MITY DIGIT "DCM" S

Scientific Devices "Digital Counting Modules" outperform any other DCM on the market today. More features than ever before! Not gaseous, not incandescent, not noisy but the modern LED. Choose from such famous manufacturers as Monsanto's MAN-1, MAN-4, Litronix 707 and 704, Opco's SLA-1 (the last 4 having characteristic heights of 0.31 at no extra charge). Each kit includes RS2" pc board with fingers for a FREE edge connector, side-mounting dip socket, LED readout of your choice, resistors, 3 IC's, and Molex connectors 33 h. Litronix (this ELIMINATES SOLDERING YOUR IC's) and 33 h. Litronix booklet, INCLUDES P.C. BOARD CONNECTOR — FREE!

Only **\$9.99**

Buy 3 — Take 10%

METAL-ENCASED

Only **\$3.50** 3 for \$9

6.3 VOLT 3 AMP Heavy-duty, 110VAC to at 3 amp filament transformer. 1/2" x 2 1/2" x 2 1/2" With color-coded wires.

POLY PAKS BLUE RIBBON Policy INCLUDES

20-Years of Business INTEGRITY

20-Years of Money-Back GUARANTEES

20-Years of Economy! LOWEST PRICES!

NOW! 48-HR. SERVICE

SANKEN HYBRID AUDIO POWER AMPS

Used extensively in hi-fi systems, tape decks, FM tuners, record players, stereo components, musical instruments, etc. All amplifiers, flat within 1 db from 100 Hz to 100,000. Each unit properly heat-sunked, with heavy-duty connecting the lug connections. Single-ended pushpull output. Power supply required 24VDC. Output to 8 ohms.

Mfr's Type	Watts	Sale
SI-1010	10	\$ 8.88
SI-1025E	25	18.88
SI-1050E	50	29.95

SILICON TUBES

SU4	\$1.49
SR4	3.95
866	7.95

HIGH VOLT TAMP SALE

P1V	SALE
2000*	1.00
3000	1.35
4000	1.65
5000	2.25
6000	2.96
8000	3.50
10000	3.95

EPOXY FULL WAVE SILICON BRIDGE RECTIFIERS

PIV	2 Amp	6 Amp
FULL WAVE	50 \$.69	\$.88
	100 \$.79	.99
	200 \$.95	1.25
	400 \$ 1.15	1.50
	600 \$ 1.35	1.75
	800 \$ 1.59	1.95
	1000 \$ 1.79	2.25

Output: 2 amp TO-18 case 6 Amp TO-18 case 1/2 x 1/2 x 1/4

SCRS! TRIACS! QUADRACS! SAME PRICE SALE!

PRV	Sale
50	\$.75
100	.95
200	1.25
300	1.50
400	1.98
500	2.25
600	2.50

10-Amp Power Tab Plastic Units Exclusive Sale

Terms: add postage. Rated: net 30. Phone Orders: Wakefield, Mass. (617) 245-3829. Retail: 16-18 Del Carmine St., Wakefield, Mass. (off Water Street) C.O.D.'S MAY BE PHONED

INCLUDES CATALOG on Fiber Optics, IC's, Semi's, Parts

POLY PAKS

P.O. BOX 942H LYNNFIELD, MASS. 01940

flea market



■ **RATES** Commercial Ads 35¢ per word; non-commercial ads 10¢ per word payable in advance. No cash discounts or agency commissions allowed.

■ **COPY** No special layout or arrangements available. Material should be typewritten or clearly printed and must include full name and address. We reserve the right to reject unsuitable copy. **Ham Radio** can not check out each advertiser and thus cannot be held responsible for claims made. Liability for correctness of material limited to corrected ad in next available issue. Deadline is 15th of second preceding month.

■ **SEND MATERIAL TO:** Flea Market, Ham Radio, Greenville, N. H. 03048.

RESISTORS: Carbon composition brand new. All standard values stocked. 1/2W 10% 40¢/\$1.00; 1/4W 10% 30¢/\$1.00 — 10 resistors per value, please. Minimum order \$5.00. 15W RMS IC Audio Amplifier — Panasonic. Frequency response 20Hz-100 kHz. 1/2% distortion. Price \$6.95 Postpaid. Pace Electronic Products, Box 161-H, Ontario Center, New York 14520.

WORLD QSL — See ad on page 92.

COLLECT WORLD STAMPS commemorating telecommunications topics. 25¢ brings mint selections on approval plus booklet "Collect Topicals and Have Fun". Alkanstamps, Box 3494, Scottsdale, AZ 85257.

MODEL 15 & 19 RTTY. Large quantity of surplus Teletype gear and accessories available from WB5CBC. Must be picked up in Las Cruces, N. M., no shipping. Details for SASE from WB5CBC or Box RTTY, Ham Radio, Greenville, NH 03048.

WARREN HAMFEST, largest family style hamfest in East. Sunday, August 18th, at famous Yankee Lake Park. Great flea market, swimming, picnicking — All Free. QSL W8VTD, Box 809, Warren, Ohio 44482.

HAMFAIR - 74 August 17th and 18th, Pierce City Fairgrounds, Graham, Wash. The outstanding hamfest in the Northwest this year. Technical seminars, contests, displays & prizes. Flea market, free camping, Saturday night dinner. Details from Bill Morgan, W7GPR, 3421 E. 138th St., Tacoma, Washington 98446.

WANTED: ARC-51, 618T-1, ARC-102, FM-633, ARC-131, 807A Wilcox, Transceivers. Pay Cash. Bob Sanett, 616 S. Holmby Ave., Los Angeles, CA. (213) 279-1275.

TELETYPEWRITERS — Kleinschmidt — portable, fixed, sets, punches, parts, reconditioned, reasonable. Mark/Space Systems, 3563 Conquista, Long Beach, Calif. 90808. 213-429-5821.

FOR THE PROMOTION OF International Radio Scouting, an attempt is being made to locate boy, girl, and adult scouts that hold amateur radio licenses. Could scouting amateurs supply me with their name, address, amateur call, class of license, scouting position, etc. Don Wibel K9ECE/W19BSA, 5115 Delaware Ave., Fort Wayne, Indiana 46805.

THE 9TH ANNUAL MELBOURNE HAMFEST is September 7-8. Air conditioned, \$1.50, tables \$2/day. PCARS, P. O. Box 1004, Melbourne, FL 32901.

STOLEN on or about May 22, 1974: Swan 400 transceiver with #406VFO, 117X AC Power Supply and D104 microphone. Eico #720 CW Transmitter, Eico #722 V.F.O., Heathkit HR-20 Receiver, Globe Scout CW Transmitter, Hallicrafters SX93 Receiver, MC-4 Mobile Console Wattmeter, Homebrew Transmatch, CD Ham M Station Console. If you have any information please contact WA2HGG or Hall of Science Radio Club, Box 1032, Flushing, N. Y. 11352.

RTTY EQUIPMENT FOR SALE including machines, parts, gears. Send us a list of your teletype needs. Atlantic Surplus Sales, 1902 Mermaid Ave., Brooklyn, N. Y. 11224.

THE NORTH TEXAS REPEATER ASSOCIATION invites all amateurs to attend the Texas VHF-FM Society Convention Friday evening, Saturday and Sunday, August 2, 3 and 4 at the Dallas West Ramada Inn in Irving Texas. Activities will include displays, technical sessions, prizes and the feature speaker, A. Prose Walker, W4BW, of the FCC. Tickets \$3 for pre-registration, \$4 at the door. Drawing for those that pre-register. Checks may be made to the Texas VHF-FM Society Convention. For information write Texas VHF-FM Society, P. O. Box 3823, Irving, Texas 75061.

FIGHT TVI with the RSO Low Pass Filter. For brochure write: Taylor Communications Manufacturing Company, Box 126, Agincourt, Ontario, Canada. MIS 384.

THE CENTRAL MISSOURI AMATEUR RADIO CLUB, Sedalia, Missouri, and The Warrensburg Amateur Radio Club, Warrensburg, Missouri, will sponsor a club station at the Missouri State Fairgrounds, Sedalia, Missouri, August 16th through August 25th. This event has been awarded the special call WMØSF.

HOMEBREWERS: Stamp brings list of high quality components. CPO Surplus, Box 189, Braintree, Mass. 02184.

HYDROPONICS for XYL while QRL. Build-yourself garden components, books, nutrients. 5 page catalog, send 40¢ refundable. Incorporated 3-1971. BURWELL GEOPONICS, Box 125-DB, Rancho Sanfe, CA 92067.

WANTED: Instruction manual for APR-4 receiver and vhf/uhf tuning units. Will return after I make a copy. Jim Fisk, editor-in-chief, Ham Radio, Greenville, NH 03048.

SWAN 350 with 117-C, clean, \$295. You ship. K1YLV, 203-272-4417.

QSL'S — **BROWNIE W3CJI** — 3035B Lehigh, Allentown, Pa. 18103. Samples with cut catalog 35¢.

WANTED: HAM RADIO January, March, April and July 1969, need to complete personal collection. KH6FMT, P. O. Box 758, Koloa Kauai, HI 96756. 808-742-2002.

DO-IT-URSELF DXPEDITION — Stay at ZF15B — Caymen Is. Vertical antenna and Caribbean at your doorstep. Diving/fishing if band folds. Write Spanish Bay Reef Resort, Box 800K, Grand Cayman, B. W. I.

SARA HAMFEST. Sunday, August 11, 1974, Riverside Park, Murphysboro, Illinois. Tickets \$1.00, 3 for \$2.00. Write Wm. Johnson, 502 W. Kenicott, Carbondale, Ill. 62901.

MIX PLEASURE WITH PLEASURE at the Hamburg International Hamfest near Niagara Falls on September 21. For information contact Lin Brownell WB2HCL, 210 Buffalo, Hamburg, N. Y. 14075.

TELL YOUR FRIENDS about Ham Radio Magazine.

OUR DIGIPET 60 IS A GENERAL-PURPOSE FREQUENCY COUNTER WITH A RATING OF 1 kHz TO 60 MHz.



(PLUS 130 MHz TO 160 MHz)

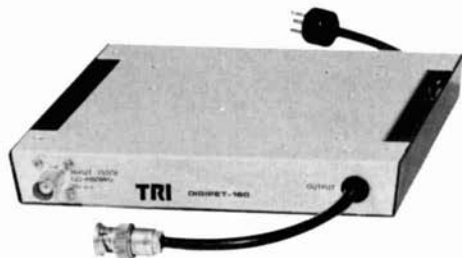

Perfectly designed for the radio amateur who wants quality, accuracy *and* economy.

If you operate around the 50 MHz band, we can offer you the Digipet 60—it measures a range of 1 kHz to 60 MHz—and it costs less than \$300.

However, if you operate up around 140 MHz, you'll want the Digipet 160 converter. It costs an additional \$50 and, mated-up with the Digipet 60, measures the critical range from 130 MHz to 160 MHz. Its AC or DC operable with complete overload protection, plus being stable (aging rate: 1 part in 10^6 /week), small (7" deep x 2½" high), sensitive (50 mVm's), flexible (five numerical-tube digits) and accurate (resolves to 1 kHz or 1 Hz, depending on gate time selected).

Write *immediately* for more information.



T.R.I. CORPORATION

505 West Olive Avenue • Sunnyvale, CA. 94086 • (408) 733-9080

NEED PARTS? We carry parts for R-388-390-390A-391-392-1051-51S1 - Nems Clark-Racal-Pack sets - PRC-25-41-47-62-70-71-73-74-77. If you need a part no matter what you have. If its U.S. government we have it or can get it. Also we want to buy or trade all aircraft communications. All ground radio communications. All plug-in modules control heads. No matter what cond. they are in - bent or busted ok. We will buy or trade. We have R-390-388-390A-392-1051-51S1 Nems Clark - Racal - and new ham gear for trade. D & R Electronics, R. D. #1, Box 56, Milton, Pa. 17847. Phone 1-717-742-4604 after 6:00 P.M.

BUY—SELL—TRADE. Write for monthly mailer. Give name, address, call letters. Complete stock of major brands new and reconditioned equipment. Call us for best deals. We buy Collins, Drake, Swan, etc. SSB & FM. Associated Radio, 8012 Conser, Overland Park, KS. 66204. 913-381-5901.

SIGNAL ONE OWNERS, expert and prompt service by ex-Signal/One engineer. Also will purchase your functioning or not functioning unit or spare parts. Write or call for details. Larry Pace, K2IXP/7, 5717 Genematas, Tucson, AZ. 85704 (602-888-5234).

WANTED: Excellent 2 meter amp. mod. transceiver. Benson, 7554 Trask Ave., Playa del Rey, Calif. 90291. (213) 823-1860. Local only.

WANTED - USED FM 2-way radio communications equipment and test equipment. Mot., GE and RCA etc. No doggies please, CAL-COM Systems, Inc., 701-51A Kings Row, San Jose, Calif. 95112, Tel. 408/998-4444.

FREQUENCY COUNTER — Motorola S1075A. Good condition, lab. certified. Freq. range: Tone freq. to 475 MHz. Sold for \$2300 when new, asking \$550. WA3NDO, 2001 Bernville Rd., Reading, Pa. 19601. (215) 373-1335.

FAX PAPER: For Desk-Fax, new (not surplus), pre-cut (not rolls), \$15 per thousand sheets, postpaid world-wide. Bill Johnston, 1808 Pomona Drive, Las Cruces, New Mexico 88001.

VHF-UHF PRE-AMPS. 432 MHz receive and transmit converters. Send for illustrated information. Carmichael Communications, P. O. Box 256, Carmichael, CA. 95608.

PRECISION HAND TOOLS, special ham-experimenter discount. Letter brings mailings, Artisan Tool Company, Box 36, Glenmont, New York 12077.

RTTY'ERS ADD PERF TAPE to your rig. Friden 2115 tape punch, 2314 Electrodata reader, and selecta data reader, \$150.00. Will work on 5, 7, and 8 channel tape. Ted Dum, 11852 Davenport Road, Los Alamitos, California 90720, 213-431-1852.

WANT OLD RADIO SHOW TRANSCRIPTION discs. Any size or speed. Send details to, Larry Kiner, W7FIZ, 7554 132nd Ave N.E., Kirkland, Wa. 98033.

THE 26TH ANNUAL South Jersey Radio Association Hamfest, Sunday, Sept. 8, 1974, at 10 A.M., rain or shine, at Molia Farms Picnic Grounds (intersection of Routes 42 and 47). Swap shops (tail-gate and table-top), electronic equipment displays, prizes, ladies' games, and grab bags for the children. Picnic tables are available; in addition, hamburgers, hot dogs, corn and soft drinks may be purchased. Free parking. Talk in on 145.2 and 3.930 MHz. Advance registration \$2; \$3 at the gate. Write to Bill Brandberg, W2BBN, 322 Lakeview Ave., Haddonfield, N. J. 08033.

TELETYPEWRITER PARTS, gears, manuals, supplies, tape, toroids. SASE list. Typetronics, Box 8873, Ft. Lauderdale, Fl. 33310. Buy parts, late machines.

PROFESSIONAL FIRE and intrusion alarm equipment and components at budget prices. From simple to most modern. SASE brings list or tell us what you need . . . Self-Contained Ionization detector fire alarm, SMOKEGUARD II, only \$65 postpaid for cash with order. ELECTRONIC EYE, 9044 Eldora Drive, Cincinnati, Ohio 45236.

WANTED: tubes, transistors, equipment, what have you? Bernard Goldstein, W2MNP, Box 257, Canal Station, New York, N. Y. 10013.

Regency HR-2B gives a lot to talk over



American Made Quality at Import Price

Full 12 Channel, 15 Watts with HI/LO power switch

Here is everything you need, at a price you like, for excellent 2 meter FM performance. The 12 transmit channels have individual trimmer capacitors for optimum workability in point-to-point repeater applications. Operate on 15 watts (minimum) or switch to 1 watt. 0.35 uv sensitivity and 3 watts of audio output make for pleasant, reliable listening. And the compact package is matched by its price.

\$229⁰⁰

Amateur Net

Regency ELECTRONICS, INC.
7707 Records Street
Indianapolis, Indiana 46226

An FM Model For Every Purpose . . . Every Purse



HR-6
12 Channel-25 Watt
6 Meter FM Transceiver

HR-220
12 Channels-10 Watts
220 MHz FM Transceiver

ACT 10-H/L/U
3 Band-10 Channel FM
Scanner Receiver

2 METER FM HEADQUARTERS

Only **STANDARD**
 sells more **STANDARDS**
 than **ERICKSON!**

and here's
ANOTHER
ERICKSON
SPECIAL
SRC-826 MA



A better BEST BUY than ever

OUR DEAL:

826 MA list	\$398.00
+ 16 extra xtals	80.00
Package list price	\$478.00
You pay only	\$359.00
YOU'VE SAVED	\$119.00

YOU GET Standard's 826MA, the best 12-channel 10-watt solid state rig on the market, factory set up on four channels plus crystal coupons for eight more channels (16 of Standard's lifetime Astropoint crystals!) of your choice; with helical-resonator front end receiver, built in provision for tone-coded squelch, rear panel test point/monitor/control sockets — all in one compact, reliable package — at a **GIANT \$119 ERICKSON** saving !!

Shipping prepaid for cashier's check or M.O.

SRC-146A with:

- Deluxe basecharger
- "Stubby" antenna
- Leather case
- Ni-cads
- 94/94, 34/94 and one other channel of your choice

List Price	\$359.00
Our Price	\$319.00
YOU SAVE	\$50.00 !!
Another BEST BUY from Erickson	



Make ERICKSON your headquarters for all your FM needs . . .

SEND QSL FOR COMPLETE SPECIFICATIONS

ERICKSON COMMUNICATIONS

3501 W. Jarvis, Skokie, IL 60076 (312) 677-2161

QSL'S SAMPLES 20¢. John Hull Printing, Rte. 6, Box 41, Duluth, Minn. 55804.

CANADIAN JUMBO SURPLUS and Parts Catalogs. Bargains Galore. Send \$1. ETCO-HR, Box 741, Montreal "A" H3c 2V2.

FREE Crystals with the purchase of any 2 meter FM radio. Write for our deal on the rig of your choice. Factory-authorized dealers for Collins, Drake, Regency, Standard, Icom, Alpha, Kenwood, Tempo, Genave, Swan, Clegg, Ten-Tec, Midland, Telex, Hallicrafters, Venus, Hy-Gain, CushCraft, Mosley, and Hustler. For the best deal around on VHF or HF gear, see us first or see us last, but see us before you buy. Write or call us today for our low quote and become one of the many happy and satisfied customers of Hoosier Electronics, R. R. 25, Box 403, Terre Haute, Indiana 47802. (812)-894-2397.

RADIO LICENSE — Exact reproduction, including signature, engraved in solid brass. Send GOOD Xerox copy with \$5.00 to Metal Art Graphics, 1136 Potomac Ave., Hagerstown, Md., 21740. Md. residents please enclose state sales tax.

COMMAND SETS WANTED: Interested in unconverted units, especially T-17/ARC-5; R-24/ARC-5 or BC-946 BCB rcvr. Need racks, mounts, control boxes, connectors. Also manuals. Mike Everette, WA4DLF, 2921 Wycliff, Raleigh, NC 27607.

QSLs CATALOG SAMPLES 35¢. Ritz Print Shop, 5810 Detroit Avenue, Cleveland, Ohio 44102.

NEW PARTS BARGAINS: Belden 100-ft. GR8 foam coax with PL259 ends 17.95; Brandes headphones (J) 5.50; Motorola HEP170 epoxy diode 2.5A/1000 PIV 2.90/10; #15 copper antenna wire; many new Sprague capacitors — write needs; CDE .001MFD/10KV doorknob cap 1.95; RG62/U 6¢/ft; RG71/U 6¢/ft; RG13B/ 15¢/ft; RG9B/U 30¢/ft; (25 ft. max single length); Belden 8214 RG8 foam 18¢/ft; Amphenol PL259 59¢; Motorola semiconductor data series books 7.50; Rider, TAB, ARRL, AMECO, Callbooks; many old tubes — write needs; new panel meters — write (4.95-7.95); Hammarlund APC50PF variable cap 1.95; Raytheon 811A 7.95, 15.00/PR; Sorensen ACR2000VA AC regulator 150.00; GE receiving tubes 50% off list; KY65 code keyer (plastic wheels) 5.95; Free parts flyer; all items new, guaranteed. Prices FOB Houston. Madison Electronics, 1508 McKinney, Houston, Texas 77002. 713/224-2668.

RECIPROCATING DETECTOR, write Peter Meacham Associates, 19 Loretta Road, Waltham, Mass. 02154.

QST FOR SALE. Send SASE for list. S. G. Simonson, 991 Park Lane North, Franklin Square, N. Y. 11010.

FT.101 MARK-2/B OWNERS. Why compromise with other more expensive RF clippers? G3LLL's RF clipper is designed only for FT.101. Talk power kilowatt class without linear (5-10 with linear!) PLUS extra R.X. gain, selectivity. Fits in minutes, no circuit board modification. Introductory price \$99 via air. Details: Holdings, 39/41 Mincing Lane, Blackburn. BB2 2AF England.

VERY in-ter-est-ing! Next 5 big issues \$1. "The Ham Trader," Sycamore IL 60178

WANTED. COLLINS 51S-1. J. Callan, 65 Beechcroft Street, Brighton, Mass. 02135.

TRAVEL-PAK QSL KIT Converts photos, post cards to QSLs! Send call and 25¢ for personal sample. Samco, Box 203H, Wynantskill, N. Y. 12198.

YAESU FT2 Auto Scanner 2M 25W Transceiver. Mint new condx., \$299 fob. W6BL, 550 Homewood Road, Los Angeles, 90049 — Herb (213) 653-2250 nites (213) 472-2413.

USED MYLAR TAPES — 1800 foot. Ten for \$8.50 postpaid. Fremerman, 4041 Central, Kansas City, Mo. 64111.

PRINTED CIRCUIT TECHNIQUES for the hobbyist. Booklet: \$2.00. H. S. steel and carbide drill bits and PC artwork. Send SASE for flyer. Trumbull, 833 Balra Dr., El Cerrito, Ca. 94530.

CALL BOOK 74

*When you want
an authoritative,
up to date directory
of licensed radio
amateurs*

It's the CALLBOOK

Over 210,000 QTH's
in the DX edition
DX CALLBOOK for 1974
\$8.95



Over 285,000 QTH's
in the U.S. edition
U.S. CALLBOOK for 1974
\$9.95

See your favorite dealer or Send today to
(Mail orders add 50¢ per CALLBOOK
for postage and handling)

WRITE FOR
FREE
BROCHURE



RADIO AMATEUR
callbook INC.
Dept. E. 925 Sherwood Drive
Lake Bluff, Ill. 60044

3 REASONS WHY YOU SHOULD BUY YOUR CALCULATOR FROM 'THE BIG T'

1. YOU GET THE BEST PRICE.... but what happens later when you want an improved model? At Tucker you can trade-up - just like a used car.

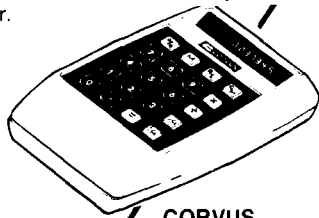

CORVUS 322 HAND-HELD PORTABLE WITH MEMORY

- 5 function (+, -, x, ÷, %) with memory
- Floating decimal, floating negative sign, 8 digit display
- Automatic constant of all functions
- Rechargeable battery pack including recharger

\$79.95

CORVUS 310 HAND-HELD PORTABLE 6 function (+, -, x, ÷, %, square root) with automatic constant, 8 digit readout, floating decimal and negative sign and many features.

With disposable batteries . . . **\$59.95**
 Disposable batteries & AC . . . **64.95**
 Rechargeable batteries & recharger **69.95**



2. Guarantees 30 day money-back guarantee...One year repair or replace guarantee and THEN TUCKER will repair any unit **after** the warranty expires for only \$9.95 (excluding any shipping and excessive damage)

CORVUS 305 DESK-TOP CALCULATOR WITH CLOCK & CALENDAR

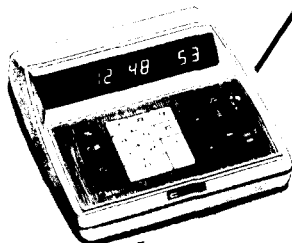

full 7 function (+, -, x, ÷, %, square root and reciprocal) with 10 digit readout, selectable 2-4 or floating decimal, automatic, constant and many features. But when the 305 isn't being used as a calculator it's a digital clock and calendar that keeps perfect time as long as it's plugged in.

Model 305 **\$99.95**
 Model 300 w/o clock **84.95**

3. Convenience You can order by mail and use your Bank cards or American Express with up to 12 months to pay. You can talk to a salesman toll free anytime - just call 800-527-4642.

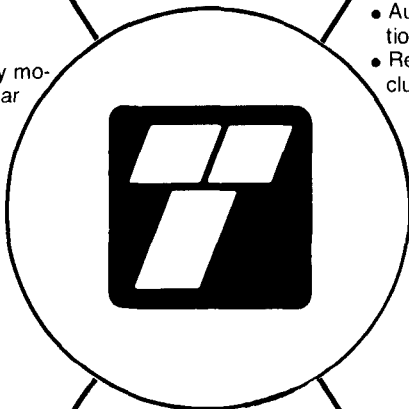

ADD \$2.75 TO EACH ORDER FOR SHIPPING.

Send check, money order, Bank Americard No., Mastercharge No. or American Express No. to: (Residents of Texas, Illinois, New Jersey & California include 5% sales tax)



TUCKER
 ELECTRONICS - COMPANY

P.O. Box No. 1050C
 Garland, Texas 75040

FOR RUSH ORDERS CALL TOLL-FREE 800-527-4642 (In Texas call 214-348-8800)

INDIANA'S FASTEST GROWING fall hamfest. Grant County ARC's annual hamfest, Sept. 29, 1974, 4-H Fairgrounds. Admission still \$1.00 for advance tickets, \$1.50 at gate. Large flea market, technical sessions, bingo for XYLs. Large inside pavillion, plenty of parking. For more information or advance tickets, write W9EBN, P. O. Box 815, Marion Ind. 46952.

URGENTLY NEED FOR SCHOOL SCIENCE PROJECT: Hammarlund HR-10 or SP600VLF; any ARC-5 receiver, especially BCB or 6-9; Rustrak tape and recorder. Call person-to-person collect Bob Ammons, 406-543-5359 or write 411 Keith, Missoula, Montana 59801. Any reasonable price.

THE IOWA 75 METER NET will hold its annual picnic on Sunday, August 25, at Riverview Park in Marshalltown, Iowa, and all amateurs and net members are urged to attend. You may check in any time. A pot luck dinner will be served at 12:00 noon. Everyone is asked to bring a covered dish. Pop and drink will be provided free. Prizes will be awarded.

PROP-PITCH MOTORS FOR SALE. Reconditioned — F.O.B. 1965 La Cuesta, Santa Ana, Calif. 92705. Days (714) 833-2133, nite (213) 835-1936.

SELL COMPLETE STATION — Transceiver Swan 500C - A. C. D. C.-W. R. L. 300B - Antennas - Dow-Keys - S.A.S.E. brings complete list prices. G. Ketchum, WBØAHR, 2856 Elm Ave., Grand Junction, Colorado 81501.

WANTED: Commercial test equipment catalogs, 1955 or earlier thru 1972. Alfred, Ballantine, Fluke, General Radio, Hewlett-Packard, Lambda, L&N, Kintel, Measurements, Tektronix, etc. Short-time loan for research project. All items will be returned if requested. Jim Fisk, W1DTY, editor-in-chief, ham-radio, Greenville, NH 03048.

HEATH IM-1202 Digital multimeter. New. \$70. Henry Ingwersen, Charlotte, VT 05445.

MOBILE IGNITION SHIELDING provides more range with no noise. Available most engines in assembled or kit forms, plus many other suppression accessories. Free literature. Estes Engineering, 543-H West 184th, Gardena, California 90248.

WANTED: Complete Collins S-line. Ken, WA5JJB, P. O. Box 355, Nederland, Texas 77627. Phone (713) 722-4196.

HAVE 1000 14 PIN IC WIRE WRAP SOCKETS. 10 for 4.00 pp. or trade for electronic components. Harold Nowland W8ZXH, 15721 Fordline, Southgate, Mich. 48195.

TECH MANUALS for Govt. surplus gear, \$6.50 each: R-220/URR, R-274/FRR, R-390/URR, URM-25D, URM-32, USM-16, TT-63A/FGC, TS-382D/U, BC-779B, TS-497B/URR, LM-21, TS-34A/AP, ALR-5, GRR-5, ARR-7, TS-323/UR, PRC-10. Thousands more available. Send 50¢ (coin) for list. W3IHD, 7218 Roanne Drive, Washington, DC 20021.

SURPLUS TEST EQUIPMENT, VHF and microwave gear; write for bulletins. David Edsall, 2843 St. Paul, Baltimore, Md. 21218.

NOVICES: 75 WATT MONOBAND transceivers 80-40 or 15 meters only \$59.50. 75 watt tribanders 80-40 and 15 only \$89.50. Unconditionally guaranteed. Fully expandable into general coverage when you get general class license. Get on the air immediately. Send for free literature. Hermes International, Box 989, Floral City, Florida.

QSL's, Sample catalog 20¢, N & S Print, P. O. Box 11184, Phoenix, Ariz. 85061.

1000 PIV AT 2.5 AMP. HEP-170 diodes. 10 for \$2.50, 50 and up 22¢ each, 100 and up 20¢ each. Postpaid U.S.A. 1N4007 1000 PIV at 1 amp. 18¢ S.A.S.E. for list. K. E. Electronics Mfg., Box 1279, Tustin, California 92680.

QUALITY CABLE TIES (6" nylon), half price, \$2.75/100 postpaid. Joe Ottinger, 106 Sheridan Ct., Leavenworth, KS 66048.

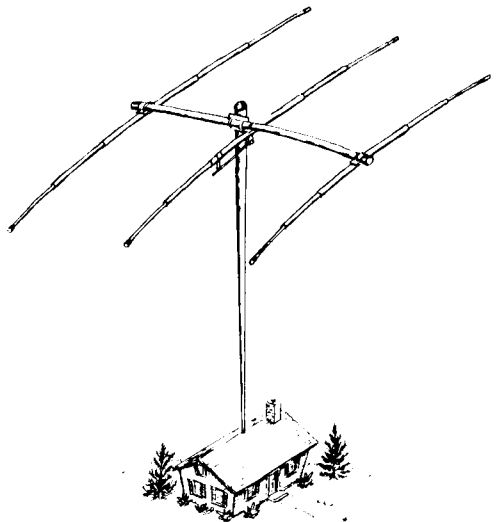

rotate YOUR HOUSE

with a . . .

CUSH CRAFT MONOBEAM

The caption may be slightly exaggerated, but we all know that the only way to get real performance is with a full size single band beam.

Cush Craft Monobeams combine superior electrical and mechanical features with the best quality materials and workmanship. They give reliable day to day amateur communications and that extra DX punch when needed for contest work or emergency communications.

A14-3	3 element	20 meters	\$120.00
A14-2	2 element	20 meters	92.00
A21-4	4 element	15 meters	100.00
A21-3	3 element	15 meters	71.00
A28-4	4 element	10 meters	62.00
A28-3	3 element	10 meters	50.00

SEE YOUR LOCAL DEALER
OR WRITE FOR FREE CATALOG

Cush
Craft
CORPORATION

621 HAYWARD STREET
MANCHESTER, N. H. 03103

2 METER FM

PORTABLE



4 CHANNELS 2 WATTS
DUAL CONVERSION

HT-144 Kit

ONLY

\$99.95

BASE \times MOBILE



RX144C
\$69.95 Kit

+

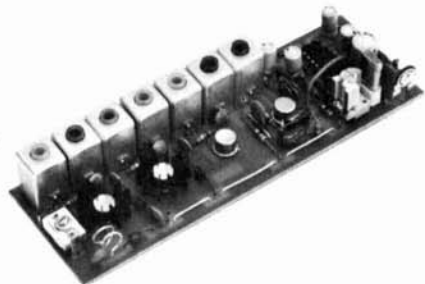

TX-144
\$29.95 Kit



VHF ENGINEERING

— DIV. OF BROWNIAN ELECT. CORP. —

320 WATER ST. POB 1921 BINGHAMTON, N.Y. 13902 607-723-9574

PERSONAL ATTENTION plus the best cash deal anywhere is what you receive at Queen City Electronics in the heart of the Midwest. Queen City carries all major brands including: Drake, Tempo, Kenwood, Yaesu, Swan, Regency, Clegg, Standard, Icom, Genave . . . Write or phone us for your equipment needs. Queen City Electronics, Inc., 7404 Hamilton Avenue, Cincinnati, Ohio 45231, (513) 931-1577.

MANUALS for most ham gear made 45/65, some earlier. Send SASE for specific quote. Hobby Industry, W0JJK, Box H-864, Council Bluffs, Iowa 51501.

HAMFESTERS 40TH ANNUAL HAMFEST and picnic Sunday, August 11, 1974, at Santa Fe Park, 91st and Wolf Road, Willow Springs, Illinois (southwest of Chicago). Exhibits for OM's, XYL's. Famous Swappers Row. Information - contact Vince Pronites, WA9EOM, 7206 So. Damen Ave., Chicago, Ill. 60636. Tickets write - Jos. Paradyla, WA9IWU, 5701 So. California Ave., Chicago, Ill. 60629.

MUST SELL: Heath SB-301 w/400Hz. filter, SB-400 w/xtal pack. All excellent condition — \$200.00 each or \$375.00 both. Will ship. WA2DGN, 159 Fisher Road, Rochester, N. Y. 14624.

TEKTRONICS 945, military 545, DC-24MHz scope delayed sweep, dual trace plug in. good cond. \$450 & ship. M. Roos, 850 Russell G-8, Santa Rosa, CA. 95401.

WANTED: GENERAL CLASS (or higher) hams to join 4,500 member Morse Telegraph Club. Hundreds of hams already belong. Send modest \$3 annual dues (includes subscription to great slick paper newspaper "Dots and Dashes") to GST A. J. Long, 520 West Schwartz Street, Salem, Ill. 62881 for membership card and assignment to nearest chapter.

EXCLUSIVELY HAM TELETYPE 21st year, RTTY Journal, articles, news, DX, VHF, classified ads. Sample 30¢. \$3.00 per year. Box 837, Royal Oak, Michigan 48068.

15TH ANNUAL NEW JERSEY QSO PARTY, Aug. 17-18. Rules from Englewood Amateur Radio Club, 303 Tenafly Rd., Englewood, NJ 07631.

PC's, Send large S.A.S.E. for list. Semtronics, Rt. #3, Box 1, Bellaire, Ohio 43906.

DANVILLE HAMFEST at Douglas Park in Danville, Illinois Sept. 1. Bowman Avenue Exit I-74 and follow the signs. Prizes. Camping and motel accommodations nearby. Food and plenty of parking available. Huge flea market and commercial displays. Tickets are \$2 or three for \$5. Advance tickets from WA9PDS, Dave, Dolan Road, Catlin, Illinois 61817. Send check or M.O. and SASE. Talk in .22/.82 and .94-simplex.

LEARN DESIGN TECHNIQUES. Electronics Monthly Newsletter. Digital, linear construction projects, design theory and procedures. Sample copy \$1.00. Valley West, Box 2119-C, Sunnyvale, Calif. 94087.

QSLs. SECOND TO NONE. Same day service. Samples airmailed 25¢. Ray, K7HLR, Box 331, Clearfield, Utah 84015.

MOTOROLA Metrum II Demonstrator (25W) \$439.95. 10% Off on all Cush-Craft, Hustler, Standard, Genave, Hy Gain, and Antenna Specialists. For all your Amateur Needs Call - BRUCE ELECTRONICS, INC., P. O. Box 724, Mt. Sterling, Kentucky 40353. 606-498-5221.

MOTOROLA PORTABLES — Expert repairs, reasonable prices, fast turn-around time. More details and flat rate catalog FREE. Ideal Services, 6663 Industrial Loop, Greendale, WI 53129.

QRP TRANSMATCH, for HW7, TenTec and others. Send stamp for details, to Peter Meacham Associates, 19 Loretta Road, Waltham, Mass. 02154.

YOUR AD belongs here too. Commercial ads 3¢ per word. Non-commercial ads 10¢ per word. Commercial advertisers write for special discounts for standing ads not changed each month.

TOUCH—TONE DECODER

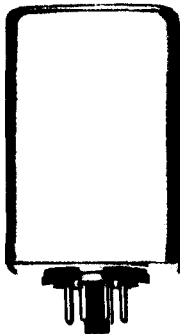

- Dual tone decoder decodes one Touch-Tone digit.
- Available for 1, 2, 3, 4, 5, 6, 7, 8, 9, 0, #, * and other dual tones 700-3000 Hz.
- Latch and reset capability built-in.

- COR control built-in.
- Relay output SPST ½-amp.
- Octal plug-in case.
- Compact 1-¾" square, 3" high.
- Free descriptive brochure on request.

T-2 Touch-Tone Decoder ... \$39.95 PPD.
Specify digit or tone frequencies.
(Include sales tax in Calif.)

PALOMAR ENGINEERS

BOX 455, ESCONDIDO, CA 92025

USED TEST EQUIPMENT

All checked and operating unless otherwise noted. FOB Monroe. Money back (less shipping) if not satisfied.

Boonton 190A Q-mtr 20-260 MHz Q5-1200	375
Boonton 202B Sig Gen AM-FM 54-216 MHz	325
Boonton 202D (sim. to above) 175-250 MHz	225
HP100D-Freq. stand. w/scope-Acc. 1ppm	85
HP185A Scope w/186B amp sampling 1GHz	335
HP202A Function Gen. .008-1200Hz	95
HP205AG Audio Gen. .02-20kHz-metered	195
HP330B Dist anal 20 Hz-20kHz .1%	205
HP524D-Freq Counter. Basic unit 10Hz-10MHz	185
HP540B Trans osc. for 524 to 12.4GHz	185
HP608B (TS510A/U) sig. gen. 10-420MHz	450
HP610B Sig Gen .45-1.2GHz calib attn	365
HP803A Imp Bridge 50-500MHz, 2-200 ohm	195
Panoramic SPA-4 Spec. Anal. Bandswitching, 10MHz-44GHz, 5 or 70MHz sweep width	985
Polarad MSG34-Sig. Gen 4.2-11GHz calib attn. AM-FM-Pulse mod.	495
Polarad R uwave rcvr 4-84GHz with plug-in AM, FM, CW, Pulse - less plug-in	225
Polarad TSA Spec. Anal .01-44GHz with plug-in less plug-in	125
Soliton 200A SCR tester-checks anode, gate volts,current,leakage and holding	165
Stoddart NM10A (URM-6) RF intens mtr 10-250 kHz, complete with acc.	630
Stoddart NM20A (PRM-1) RF intens mtr 15-25MHz, complete with acc.	655
Stoddart NM52A-RFI mtr, .375-1GHz, w/acc.	985
Tek RM 15-DC-15MHz GP scope	265
Tek 181 Time mark generator	95
Tek 190A Const. Ampl. Sig. Gen .35-50MHz	125
Tek 565 dual beam 10MHz scope, less plug-ins	625
TS-403A Sig. Gen. (HP616) 1.8-4GHz	385
URM 7 RI-FI mtr. (sim. NF-105) 20-400MHz	750

GRAY Electronics
P. O. Box 941, Monroe, MI 48161
(Send SASE for complete list)
Specializing in used test equipment

VHF
DX OPS

MODEL 60 SPEECH PROCESSOR — QRO the average-to-peak ratio of the speech waveform as much as 8 db using a logarithmic principle. Operates with FM, SSB and AM transmitters and transceivers. Low/High impedance Mic input. Two 9Vdc batteries provide a self-contained unit.

Model 60W (Processor Assembled) \$29.95
Model 60K (Processor Kit) \$23.95
200-15 (Processor Board Kit) \$14.95

QRO
?

MODEL 20 DIGITAL DIAL — Available for Collins and Drake gear. Optional four digit readout and crystal time base QSY your fixed or mobile transmitter, receiver or transceiver with 100 Hz accuracy and no last digit jitter. Simple one wire connects dial to rig and you're ready to go. **Specify your type of rig.**

Model 20 (5-5.5 Mhz VFO range).....\$169.95
Model 20C (Collins).....\$169.95
Model 20D (Drake).....\$169.95
Options: (4 Digit Readout).....\$ 29.95
(Crystal Time Base).....\$ 29.95

CW
OPS

MODEL 11A PADDLE — Designed with reliability in mind. No mechanical switches or bearings to fail. Paddle contact spacing adjusts easily.

Model 11A (Assembled) \$11.95

MODEL 10A ELECTRONIC KEYS — Has NEW features at no extra cost: Linear Speed Control and Operate/Tune Switch. Plus internal pentight cells and reed relay output provide a compact, portable, versatile unit.

Model 10AW (Keyer & Sidetone Assembled) \$39.95
Model 10AW (Keyer Assembled) \$29.95
Model 10AK (Keyer Kit) \$23.95
200-2K (Keyer Board Kit) \$14.95
200-3K (Sidetone Board Kit) \$ 9.95

MATRIC

DEALERS:

VE AMATEUR RADIO SALES, Downsview, Ontario, Canada •
SST ELECTRONICS, Lawndale, CA 90260 • GARY RADIO, INC.,
San Diego, CA 92111 • KASS ELECTRONICS DISTRIBUTORS,
Drexel Hill, PA 19026 • M. WEINSCHENKER K3DPJ,
Irwin, PA 15642 • HAMTRONICS, Trevose, PA 19047

BOX 185A • FRANKLIN, PA. 16323

PHONE: 814 432-3647

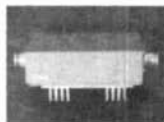
T
D
S

SOLID STATE 2M AMPLIFIER
50 ohms input/output; 1-3
watts in, 10 watts out; auto-
matic solid state switching
12 VDC

Kit Less Case \$24.95
Kit With Case 27.95
Assembled, Tested 39.95

**ADJUSTABLE REGULATED
POWER SUPPLY**
2-15 VDC, 4 amp @ 13
VDC. Perfect for powering
solid state 2M FM rigs.

Kit Less Case \$25.95
Kit With Case 29.95
With Meter, Add 10.00

Allow \$2.00 postage — VA. residents add 4% tax.
Send check or money order to:
TEKPRO DESIGN SYSTEMS
P. O. BOX 6324
VIRGINIA BEACH, VA. 23456

RTTY Converters
now available —
Write for Free
information

WORLD QSL BUREAU

THE ONLY QSL BUREAU to handle all of your QSLs to anywhere; next door, the next state, the next country, the whole world. Just bundle them up (please arrange alphabetically) and send them to us with payment of 6¢ each.

5200 Panama Ave., Richmond, CA USA 94804

Cash for any Collins military or commercial equipment or parts, especially 618 T Tranceivers. 490 T antenna couplers. AN/ARC-102. AN/ARC-94.

CASH

AN/MRC-95. SPACE ELECTRONICS CO.,
76 Brookside Drive, Upper Saddle River, N.J. 07458
(201) 327-7640

COMPLETE ANTENNA SYSTEMS

A complete ready-to-use antenna system designed for your favorite frequency. Includes No. 12 copperweld wire element dipole, 100 ft. of coax with connector, and 100 ft. of 3/4 inch diameter dacron halyard at each end of dipole. No "diddling" or trimming required. You furnish the supports, plug the feedline into your xmitr and start operating. Power rating — 2KW, VSWR 1.5:1 or less.

75/80M Monoband 130 Ft. \$ 74.75
40M Monoband 65 Ft. 69.75
80/40M Dualband 130 Ft. 99.95
80/40/20M Triband 130 Ft. 133.00

Descriptive literature available. State desired frequency. Postpaid contiguous USA.

HOUSE OF DIPOLES

Box 8484 Orlando, Fla. 32806



Radio Amateurs
Reference Library
of Maps and Atlas

WORLD PREFIX MAP — Full color, 40" x 28", shows prefixes on each country . . . DX zones, time zones, cities, cross referenced tables \$1.25

RADIO AMATEURS GREAT CIRCLE CHART OF THE WORLD — from the center of the United States! Full color, 30" x 25", listing Great Circle bearings in degrees for six major U.S. cities: Boston, Washington, D. C., Miami, Seattle, San Francisco & Los Angeles. \$1.25

RADIO AMATEURS MAP OF NORTH AMERICA! Full color, 30" x 25" — includes Central America and the Caribbean to the equator, showing call areas, zone boundaries, prefixes and time zones, FCC frequency chart, plus useful information on each of the 50 United States and other Countries. \$1.25

WORLD ATLAS — Only atlas compiled for radio amateurs. Packed with world-wide information — includes 11 maps, in 4 colors with zone boundaries and country prefixes on each map. Also includes a polar projection map of the world plus a map of the Antarctica — a complete set of maps of the world. 20 pages. size 8 3/4" x 12" \$2.50

Complete reference library of maps — set of 4 as listed above \$3.75

See your favorite dealer or order direct.

Mail orders please include 50¢ per order for postage and handling.

WRITE FOR
FREE
BROCHURE!

RADIO AMATEUR
callbook INC.



Dept. E 925 Sherwood Drive
Lake Bluff, Ill. 60044

LEARN RADIO CODE

THE EASY WAY!

- No Books To Read
- No Visual Gimmicks To Distract You
- Just Listen And Learn

Based on modern psychological techniques—This course will take you beyond 13 w.p.m. in LESS THAN HALF THE TIME!
Available on magnetic tape \$9.95 — Cassette, \$10.95



\$9.95

Album contains three 12" LP's 2 1/2 hr. Instruction

EPSILON [E] RECORDS

508 East Washington St., Arcola, Illinois 61910

7-SEGMENT READOUT
12-PIN DIP

- Three digits with right-hand decimal
- Plugs into DIP sockets
- Similar to (LITRONIX) DL337
- Magnified digit approximately .1"
- Cathode for each digit
- Segments are parallel for multiple operation

EACH \$3.00 4 (12 Digits) \$11.00

BRAND NEW

RCA NUMITRON

EACH.....\$ 5.00

SPECIAL: 5 FOR \$20.00

DR2010



Potter & Brumfield

TYPE KHP RELAY 4 PDT 3A

CONTACTS

24 VDC (650 coil)....\$1.50

120 VAC (10.5 MA coil).... 1.75



Power Supply SPECIAL!

723 DIP variable regulator chip 1-40V, + or - output @ 150 MA 10A with external pass transistor—With diagrams for many applications.

EACH...\$1.00 10 FOR...\$8.95

CT5005 CALCULATOR

This calculator chip has a full four-function memory, which is controlled by four keys, M (Adds entry into memory), -M (Subtracts entry from memory), CM (clear memory, without clearing rest of registers), RM (read memory or use as entry).

12-Digit display and calculate

Fixed decimal at 0, 1, 2, 3, 4, or 5

Leading zero suppression

7-Segment multiplexed output

True credit sign display

Single 28-pin chip

CHIP AND DATA.....ONLY \$14.95

DATA ONLY (Refundable)..... 1.00

5001 CALCULATOR

40-Pin calculator chip will add, subtract, multiply, and divide. 12-Digit display and calculate. Chain calculations. True credit balance sign output. Automatic over-flow indication. Fixed decimal point at 1, 2, 3, or 4. Leading zero suppression. Complete data supplied with chip.

CHIP AND DATA.....ONLY \$9.95

DATA ONLY (Refundable).... 1.00

5002 LOW POWER CHIP AND DATA...12.95

All ICs are new and fully-tested; leads are plated with gold or solder. Orders for \$5 or more will be shipped prepaid. Add 35c for handling and postage for smaller orders; residents of California add sales tax. IC orders are shipped within 2 workdays—kits are shipped within 10 days of receipt of order. \$10.00 minimum on C.O.D.s (phone in).

MAIL ORDERS:
P. O. Box J 4811 Myrtle Ave.
Carmichael, CA Sacramento, CA
95608 (916) 334-2161

MONEY BACK GUARANTEE ON ALL GOODS!

SEND FOR FREE FLYER LISTING 100's OF MONEY-SAVING BARGAINS!

BABYLON ELECTRONICS

CTμL SPECIAL:

Complementary Transistor Logic

This logic family is unique in that both NPN and PNP transistors are combined in the same package. Unlike TTL and DTL, the outputs are current sources (in the high state) as well as sinking current in the low state. Those are brand new units, some of which are mis-marked with DTL numbers.

CTL 9956 dual 2-in-p
AND buffer

CTL 9953 2-2-3inpu
AND/OR gate

CTL 9952 dual 2-in-
put NOR gate

Data supplied; all parts are dual-in-line.

MIX OR MATCH 5 FOR \$1.00



LED's

MV50 red emitting \$.20
10-4 ma @ 2V 10 FOR 1.25

MV5024 red TO-18 \$.35
high dome 10 FOR 2.95

MV10E visible red \$.30
5-7 ma @ 2V 10 FOR 2.50

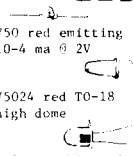

CMOS

CD4001 \$.75 74C20 .75
CD4002 .75 74C160 3.25

3-Amp Power Silicon Rectifiers

Marked Epoxy Axial Package

PRV	PRICE	PRV	PRICE
100.....	\$.10	800.....	\$.30
200.....	\$.15	1000....	\$.40
400.....	\$.18	1200....	\$.50
600.....	\$.23	1500....	\$.65

MAN 1

7-Segment, 0-9 plus letters. Snaps in 14-pin DIP socket or Molex. Operates with IC voltage requirements. Long operating life.

ONLY \$3.25



7400	\$.25	74L51	\$.30
74H00	\$.35	74H51	\$.35
7401	\$.20	7453	\$.40
74H01	\$.35	7454	\$.25
7402	\$.35	74L54	\$.35
7403	\$.30	74L55	\$.35
7404	\$.28	7460	\$.20
74H04	\$.35	74L71	\$.20
7405	\$.28	7472	\$.40
7406	\$.70	74L72	\$.50
7408	\$.35	7473	\$.60
74H08	\$.35	74L73	\$.75
7410	\$.25	7474	\$.65
74H11	\$.35	74H74	\$.80
7413	1.25	7475	1.40
7417	\$.40	7476	\$.60
7420	\$.25	74L78	\$.80
74L20	\$.35	7480	\$.65
74H20	\$.35	7483	1.00
74H22	\$.35	7489	4.00
7430	\$.25	7490	1.20
7430	\$.40	7492	1.15
7440	\$.25	7495	1.15
74H40	\$.35	74L95	2.00
7441	1.25	74107	2.00
7442	1.20	74121	1.25
7446	1.75	74154	2.30
7447	1.50	74193	1.50
7448	1.50	74195	1.00
7450	\$.25		
74H50	\$.35		
7451	\$.25		

7400 Series DIP

RECTIFIERS

VARO FULL-WAVE BRIDGES

V5447 2A 400V \$.90
V5647 2A 600V 1.10

MR810 Rect. 50V 1A .10



Special 811: Hex Inverter

TTL DIP Hex Inverter; pin interchangeable with SN 7404. Parts are brand new and are branded Signetics and marked "811."

Data Sheet Supplied

EACH.....\$.30
10 FOR..... 2.50
100 FOR..... 23.00
1000 FOR..... 220.00

811



0-9 plus letters. **MAN 3**

Right-hand decimal point. Flat-pack type case. Long operating life. IC vol- EACP \$1.25

tage requirements. Ideal 10 OR MORE 1.00 for pocket calculators!



MAN4 Seven-segment, 0-9 plus letters. Right-hand decimal point. Snaps in 14-pin DIP socket or Molex. IC voltage requirements. Ideal for desk or pocket calculators!

EACH.....\$2.75
TEN OR MORE 2.50 EACH

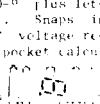

CD-2 Counter Kit

This kit provides a highly sophisticated display section module for clocks, counters, or other numerical display needs. The unit is 1.8" wide and 4 5/8" long. A single 5-watt power source powers both the ICs and the display tube. It can attain typical count rates of up to 30 MHz and also has a lamp test, causing all 7 segments to light. Kit includes a 2-sided (with plated thru holes) fiberglass printed circuit board, a 7496, a 7475, a 7447, a DR 2010 RCA Numitron display tube, complete instructions, and enough Molex pins for the ICs. BOTH boards can be supplied in a single panel of up to 10 digits (with all interconnects); therefore, when ordering, please specify whether you want them in single panels or in one multiple digit board. Not specifying will result in shipping delay.

COMPLETE KIT, ONLY \$11.95

FULLY-ASSEMBLED UNIT \$15.00

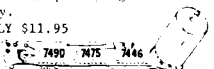

Boards supplied separately @ \$2.50 per digit.

LINEARS

NE540	70-Watt power driver amp.....	\$2.00
NE555	Precision timer.....	1.50
NE560	Phase lock loop DIP.....	3.25
NE561	Phase lock loop DIP.....	3.25
NE565	Phase lock loop TO-5.....	3.25
NE566	Function generator TO-5.....	4.00
NE567	Tone decoder MINI DIP.....	4.00
NE567	Tone decoder TO-5.....	3.00
NE5558	Dual 741 op amp MINI DIP.....	1.00
709	Popular Op Amp DIP.....	.45
710	Voltage comparator DIP.....	.75
711	Dual comparator DIP.....	.40
723	Precision voltage regulator DIP.....	1.00
739	Low noise op amp DIP unmarked.....	1.00
741	Op amp TO-5/MINI DIP.....	.55
747	Dual 741 op amp DIP.....	1.00
748	Op amp TO-5.....	1.00
CA3018	2 Isolated transistors and a Darlington-connected transistor pair.....	1.00
CA3026	Dual differential amp.....	1.00
CA3045	5 NPN transistor array.....	1.00
LM100	Positive DC regulator TO-5.....	1.00
LM105	Voltage regulator.....	1.25
LM302	Op amp voltage follower TO-5.....	1.25
LM308	Op amp TO-5.....	2.00
LM309H	5V 200 MA power supply TO-5.....	1.00
LM309K	5V 1A power supply module TO-3.....	2.00
LM311	Comparator TO-5.....	1.75
LM370	AGC amplifier.....	2.00
LM380	2-Watt Audio Amp.....	1.75
LM595	4-Quadrant multiplier.....	2.00
MC1536T	Op Amp.....	2.00

Advertisers check-off

... for literature, in a hurry — we'll rush your name to the companies whose names you "check-off"

Place your check mark in the space between name and number. Ex: Ham Radio 234

INDEX

ATV*	K. E. 072
Amtech 006	Leland 193
Atlas 198	Logic 133
Babylon 014	MFJ 082
Barry*	Martex 197
Bauman 017	Matric 084
Budwig 233	McClaren 155
CFP 022	Midland 086
Caddell 244	Nasem 249
Communications	Nurmi 090
Unltd 248	Palomar 093
Comtec 151	Poly Paks 096
Cush Craft 035	Prof. Elect. 140
Delavan 235	RMS 239
Drake 039	Callbook 100
ECM 190	Raytheon 101
Ehrhorn 042	Regency 102
Eimac 043	Robot 103
Electronics	SAROC 146
Center 236	Space-Military .. 107
Epsilon 046	Specialty 216
Erickson 047	Spectronics FM .. 191
Expo '74 147	Spectrum 108
General Aviation .. 168	Swan 111
Gray 055	Symtek 203
Greene's 253	T. R. I. Corp. 225
Gregory*	Tech. Doc. 226
Hal 057	Tekpro 250
Hal-Tronix 254	Tri-Ex 116
Ham Radio 150	Tri-Tek 117
Hamtronics 246	Tucker 113
Henry 062	VHF Eng. 121
House Dipoles 036	Webster 255
Icom 065	Weinschenker .. 122
International	Wide Band Eng. .. 256
Crystal 099	Wilson 123
International Field Day*	Wolf 124
Jan 067	World QSL 125
Janel 068	Yaesu 127

*Please contact this advertiser directly

Limit 15 inquiries per request.

August 1974

Please use before September 30, 1974

Tear off and mail to
HAM RADIO MAGAZINE — "check off"
 Greenville, N. H. 03048

NAME.....
 CALL.....
 STREET.....
 CITY.....
 STATE.....ZIP.....

Advertisers iNdex

ATV Research	68
Amtech	75
Atlas Electronics	63
Babylon Electronics	93
Barry	96
Bauman	68
Budwig Manufacturing Co.	80
CFP Enterprises	78
Caddell Coil Corp.	69
Communications Unlimited	73
Comtec	69
Cush Craft	39, 89
Delavan Electronics, Inc.	72
Drake, Co. R. L.	43
ECM Corporation	78
Ehrhorn Technological Operations, Inc.	1
Eimac, Div. of Varian Assoc.	Cover IV
Electronics Center, Inc.	68
Epsilon Records	92
Erickson Communications	67, 86
Expo '74	70
Gray Electronics	91
Greene's Electronics	69
Gregory Electronics	67
Hal Communications Corp.	55, 75
Hal-Tronix	80
Ham Radio	48, 49, 67
Hamtronics, Inc.	69
Henry Radio Stores	Cover III
House of Dipoles	92
Icom	77
International Crystal Mfg. Co. Inc.	74
International Field Day	67
Jan Crystals	80
Janel Labs	68
K. E. Electronics	75
Leland Associates	69
Logic Newsletter	72
MFJ Enterprises	68
Martex Corporation	78
Matric	92
McClaren	76
Midland Electronics Company	80
Nasem	76
Nurmi Electronic Supply	65
Palomar Engineers	91
Poly Paks	82
Professional Electronics	75
RMS Corporation	80
Radio Amateur Callbook	87, 92
Raytheon Company	2
Regency Electronics, Inc.	85
Robot Research	81
SAROC	67
Space-Military Electronics	92
Specialty Products	72
Spectronics FM	71
Spectrum International	78
Swan Electronics	Cover II
Symtek, Inc.	76
T. R. I. Corporation	84
Technical Documentation	66
Tekpro Design Systems	92
Tri-Ex Tower Corp.	5
Tri-Tek, Inc.	67
Tucker Electronics	88
VHF Engineering, Div. of	
Brownian Elect. Corp.	90
Webster Radio	75
Weinschenker, M.	69
Wide Band Engineering Co. Inc.	72
Wilson Electronics	79
Wolf, S.	76
World QSL Bureau	92
Yaesu Musen USA	95

Incomparable

FT-101B

Proven Performance

SOLID-STATE 160-10 METER TRANSCEIVER



ASK THE AMATEUR WHO OWNS ONE
AND LEARN WHY ACTIVE AMATEURS
WORLD-WIDE CHOOSE YAESU

"THE TOTAL PERFORMANCE LINE"

VISIT YOUR DEALER FOR DETAILS AND OUR NEW CATALOGUE

All Yaesu products warranted by the selling dealer
Complete after warranty factory service available



YAESU MUSEN USA INC.

7625 E. Rosecrans Ave., Unit #29, Paramount, CA. 90723
(213) 633-4007

2-METER AMPLIFIERS

MODEL	PW IN	PW OUT	KIT PRICE	WIRED & TESTED PRICE
PA-1202-H	7.5	15	\$39.95	\$49.95
PA-1501-H	7.5	15	\$49.95	\$54.95
PA-2011-H	14.4	25	\$59.95	\$74.95
PA-4010-H	5.12	40	\$39.95	\$44.95
PA-1102-80	13.6	110	N.A.	\$149.95
PA-1101-10	9.12	110	N.A.	\$179.95
PA-144-15	7.1	15	\$39.95	
PA-144-25	7.1	25	\$49.95	
PA-220-15	7.1	15	\$39.95	

Regulated Power Supplies

PS-12 ADJ 11-15 VDC 12 amp. **Wired \$79.95**
 Kit **\$59.95**
 PS-24 ADJ 11-15 VDC 24 amp. **Wired \$89.95**
 Kit **\$69.95**

HT-144 Handheld Kit: 2 meters, 2 watts, complete less batteries and crystals **\$99.95**

B & W WATERS Model 334-A

ONE KW WATTMETER
 LARGE METER WITH 10, 100,
 300 & 1,000 WATT SCALES
\$149.95 PREPAID

HF Gear from Barry

Hustler 4BTV Vertical Antenna **\$56.95**
 Famous Triton-II by Ten-Tec. Fully solid-state, 200 watt transceiver. 5 bands - full break in on CW **\$606.00**
 Ten-Tec 252 AC Power Supply with VOX **\$119.00**
 Drake TR-4C Transceiver new, **\$599.95**
 Drake AC-4 Power Supply **\$120.00**

NPC POWER SUPPLIES

115 VAC input - 12 VDC 4 amps out **\$24.95**
 Same as above but regulated **\$34.95**
 Model 108R --- 115 VAC/13.6 VDC 12 amps max. REGULATED **\$69.95**

R-392/URR by Collins & others. 500 kc to 31.99 Mc, digital readout similar to R-390. 24 volts dc at 3 amps. Very good condition. Introductory offer subject to change **\$195.00**

R-389/URR 15 to 1500 kc. Manual or motor tuned with digital readout. Very good **\$495.00**

Collins 30L-1 Linear Amplifier good, **\$375.00**

Collins 75A-4 with AM, SSB & CW filters plus Collins speaker and Book **\$395.00**

Heath SB-301 with SB-620 Scanalyzer and SB-600 Speaker Write

Servo Corp. R-5200 Receiver 50 to 250 Mc continuous CW, FM, AM, adjustable selectivity, 115 volt AC **\$195.00**

Kenwood TS-511S with Kenwood PS-511S, Mint. Both for **\$395.00**

Hunter Bandit Linear Amplifier, Ex. Cnd. **\$495.00**

HQ-170 - Hammarlund 170 6-160 meter with/clock: Exc: **\$195.00**

HQ-180 - Hammarlund General Coverage with/clock: Good Cond: **\$225.00**

HQ-215 - Hammarlund Solid State Amateur Receiver: Very Good: **\$245.00**

Drake 2NT Transmitter Like new **\$125.00**

LATE ARRIVALS:

Drake T-4XC Just arrived **\$580.00**

Drake SPR-4 Just arrived **\$579.00**

Drake AA-10 Amplifier for TR-22 **\$49.95**

Drake AC-10 Pwr. Sup. for TR-22, AA-10 or TR72 **\$44.00**

SB-200 Heath Linear Amplifier Exc. 10-80 meters: **\$195.00**

Heath SB620 Scanalyzer: **\$125.00**

Collins MP-1 Mobile 12 VDC Power Supply: Good Cond: **\$89.00**

Collins 312-B5 VFO Wattmeter: Exc. Cond. **\$395.00**

VENUS

SS-2, SLOW SCAN MONITOR
 Hood \$15, CG Test Tape \$9.50 - **\$349.00**
 C1, FAST SCAN/SLOW SCAN
 CAMERA & CONVERTER - **\$469.00**

Gold Line Single Pole, 5 position coaxial switch, wall bracket or panel mount, 1 KW AM **\$17.95**
WE STOCK BIRD MODEL 43 THRU LINE WATT-METERS: WE ARE OFFICIAL DISTRIBUTORS

Clegg FM-27B, 146-148 Mc coverage without buying a crystal. Fully synthesized 25 w. out **\$479.95**
 Shipping prepaid on all FM-27B's

Tube Headquarters. Diversified Stock. Heavy Inventory of Eimac tubes, chimneys, sockets, etc. 3-500Z **\$42.50**

Drake SC-6, 6 meter Rec. converter with Drake CC1 console: **\$120.00**

Drake TC-6 6 meter trans. converter **\$278.00**

Mallory UHF Inductuner, covers 50-250Mc \$9.95 ea

SWR Bridge less meter by Automatic Electric. To 800 Mcs. TNC connectors, \$10 value **\$9.95**

Same with N connectors **\$14.95**

Courier ML-100 Mobile Linear Amp. 100 input-200 watts pep, 10 meter operation: New **\$120.00**

CONSTANT VOLTAGE TRANSFORMER. Input 115 VAC @ 60 Hz output, 24 Volts @ 15 amps regulated (plus or minus 1%) requires 6 mfd capacitor (not furnished) **\$40 value \$14.95 ea.**

Tempo CL-146 w/GLB 400B Synthesizer 5kc split **\$395.00**

Drake TR-72, 2-meter FM transceiver, 23 channels, 1 or 10 watts output, 13.8 volts **\$320.00**

FM from Barry

IC-230 by Inoue

Completely synthesized with phase locked loop, Single Knob Control, Smart compact styling.

\$489.00

Collins 152-J1 Phone Patch, good, removed from equip. with detailed schematic **\$24.95**

Deluxe Headsets, excellent for ham radio or audio visual labs: 600 ohms, vinyl cushioned: **\$9.99**

With volume control **\$11.99**

C.D. Ham II Rotator

New Improved **\$149.95**

write or call for introductory offer

TR-44 complete with control box

\$69.95

8 conductor cable for HAM II & TR-44 Rotators **15¢/ft.**

CASH PAID . . . FAST! For your unused TUBES, Semiconductors, RECEIVERS, VAC. VARIABLES, Test Equipment, ETC. Write or call Now! Barry, W2NLI. We Buy! We ship all over the World. Thousands of Unadvertised specials. F.O.B. point of shipment. Add sufficient funds for shipping. Excess refunded.

Send for Green Sheet Supplement 23. Send 50¢ postage & handling.

BARRY 512 Broadway NY, NY 10012

DEPT. H-8

212-WA-5-7000

TELEX 12-7670

ELECTRONICS

We're overwhelmed!

...but not surprised by your acceptance of
the new
TS-520



**WE KNEW THIS NO-COMPROMISE, DO EVERYTHING, GO EVERYWHERE
TRANSCEIVER WOULD BE POPULAR. NOW WE ARE DELIVERING THEM IN
RECORD NUMBERS. PLEASE BE PATIENT...WE HAVE ONE FOR YOU.**

Here are 30 special reasons you will want to own a TS-520. After you have operated one, you will doubtless give us 30 more why you're glad you own one.

- | | | |
|--|--|--|
| 1. Built-in AC power supply | reliable with heater switch for mobile receive-only operation | 22. Full metering |
| 2. Built-in 12 volt DC power supply | | 23. Selectable SSB |
| 3. Built-in VOX with adjustable gain, delay and anti VOX | 13. Built-in cooling fan | 24. Selectable AGC operation for different modes |
| 4. 1 KHz dial readout | 14. Accessory external VFO & accessory external speaker | 25. VFO indicator light |
| 5. Ultra stable FET linear VFO | 15. Built-in speaker | 26. Built-in selectable ALC action for speech processing |
| 6. Built-in noise blanker | 16. Modern styling & functional design. Modular construction. | 27. Carrying handle |
| 7. Built-in RIT circuit and RIT indicator light | 17. Amplified ALC | 28. Rugged 6146 type final tubes |
| 8. 8 pole crystal filter | 18. TUNE position increases tube life | 29. Internal cross-channel operation. |
| 9. Built-in 25 KHz crystal oscillator | 19. Maximum TVI protection | 30. Push button WWV reception |
| 10. Provisions for optional CW filter | 20. Built-in fixed channel operation (4 channels) with indicator light | |
| 11. Break-in CW with sidetone | 21. Provisions for use with a VHF transverter | |
| 12. Completely solid state except final section. Compact, low current, | | |

Proven Kenwood quality and reliability

The price...\$629.00

subject to change without notice.

Accessories: External VFO-(VFO-520), External speaker - (SP-520), CW Filter - (CW-520)

Available from
Kenwood dealers
throughout the U.S.

Henry Radio

11240 W. Olympic Blvd., Los Angeles, Calif. 90064 213/477-6701
931 N. Euclid, Anaheim, Calif. 92801 714/772-9200
Butler, Missouri 64730 816/679-3127

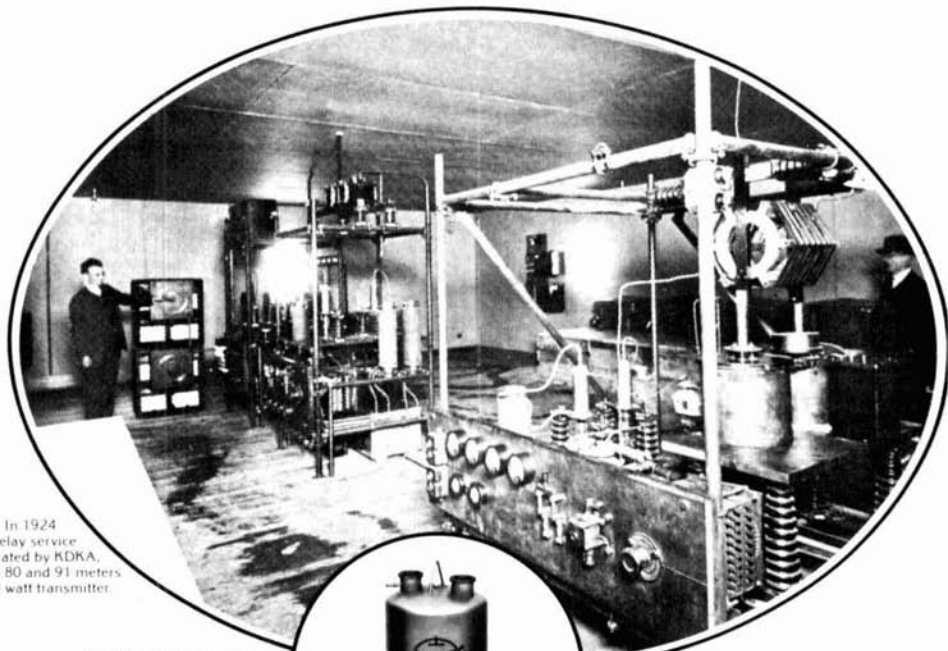

In 1924 shortwave relay service was inaugurated by KDKA, Pittsburgh, on 80 and 91 meters using this 500 watt transmitter.

EIMAC brought broadcasting from where it was to where it is.



Today, the EIMAC X-2159 super power tetrode.

50 years of progress in communications. 1924 saw the inception of widespread scheduled broadcasting in the United States and Europe. The first shortwave relay broadcast station was a success. The arc and spark transmitters of the early "twenties" were being eclipsed by the fragile, gassy vacuum tube.

Today, fifty years later, international and domestic broadcasting benefit from EIMAC's pioneer developmental work in vacuum tube technology. EIMAC leadership in high power and microwave devices of all types make possible applications considered impossible a few years ago.

EIMAC's family of high gain tetrodes, including the super power X-2159, are predominant for broadcast service, powering today's transmitters and ready to power tomorrow's super power transmitters.

EIMAC develops, others copy or fade away, as the last 50 years have proven.

Look to EIMAC for dependability and cost-effectiveness in vacuum tubes. EIMAC has the answer **today** for tomorrow's communication requirements.

For further information, contact EIMAC, Division of Varian, 301 Industrial Way, San Carlos, California 94070. Or any of the more than 30 Varian/EIMAC Electron Tube and Device Group Sales Offices throughout the world.

